

PASCO Science Technology

Biology • Chemistry • Environmental • Physics

NEW! Wireless Sensors

Wireless EKG, Geiger Counter, and more!

(Pages 108-109)

NEW! STEM Solutions

Coding meets STEM in these hands-on kits.

(Pages 18-31)

Lab Stations

Everything you need in one convenient case.

(Pages 6-7)

NEW

PASCObot

Sense & Control with the all new PASCObot! (Pages 28-29)

A blue PASCObot robot with a yellow sensor on top and a grey claw-like mechanism on the front.

NEW



Wireless EKG
Page 45



Wireless Soil Moisture
Page 70



SPARK LXi2 Datalogger
Page 124



UV-Vis Spectrometer
Page 65



Wireless Force Platforms
Page 101



Wireless Geiger Counter
Page 99

PASCO's Wireless Smart Carts

The patented Smart Cart is the next generation in dynamics carts for the science classroom.

The Smart Cart begins with PASCO's low-friction dynamics cart and adds wireless sensors that measure position, velocity, acceleration, force, and rotation. (pages 91-94)

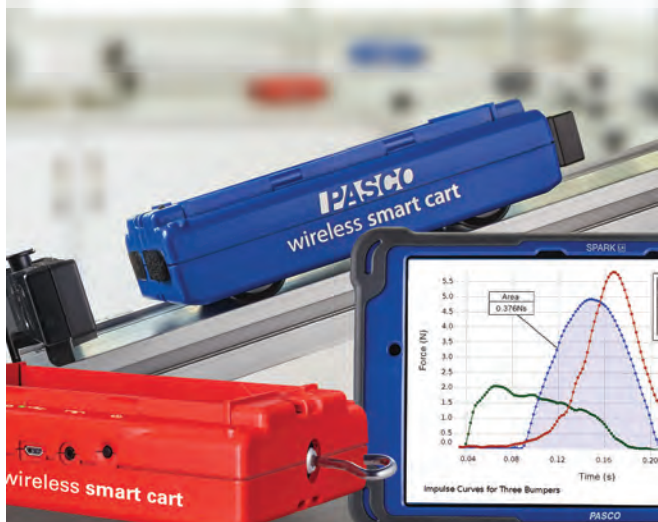

Greenhouse Sense & Control Kit

Designed for the exploration of biological and ecological concepts, the Coding with Greenhouse Sensor Technologies Kit includes everything students need to design, build, program, and study their very own greenhouse. (pages 30-31)



Table of Contents

PASCO Solution Overview	2
Elementary.....	8
MindLabs.....	12
Middle School	14
STEM/Coding	18
Biology	32
Chemistry	48
Environmental.....	66
Physics	78
Sensors	108
Storage.....	142
Index.....	144
Order Form.....	150
Support & Consulting.....	152

PASCObot Sense & Control Kit

The PASCObot Sense & Control Kit helps harness students' interest in robotics to drive deeper learning in science and STEM. The PASCObot opens a new world of opportunity for students to grow, create, and even compete! (pages 26-29)





Sensor Technology

Our innovative, award-winning wireless sensors are rugged, low-cost, and easy to use. Explore our growing line of more than 30 wireless sensors!



Data Collection & Analysis Software

Intuitive SPARKvue® works on iOS, Android™, and Chrome™ devices, as well as Mac® and Windows® computers. It even includes Blockly block-based coding, which allows students to code with any PASCO sensor.



Complete Lab Stations

PASCO Lab Stations make it easy to use sensor-based technology in your science classroom. Discover Lab Stations for Biology, Chemistry, Agricultural Science, Physics, Middle School Science, and K-5 Science.



Curriculum Solutions

The Essential curriculums are the only curricular solutions that include a Student Textbook, an e-Book, Teacher e-Resources, Lab Manuals, and award-winning equipment kits.



STEM & Coding Solutions

STEM Sense solutions promote early excellence in science and STEM education with cross-curricular investigations that help young learners build strong foundations in science, programming and data literacy.



Storage & Classroom Management

Use these rolling carts and storage trays to decrease your classroom management time and increase teaching and learning time.



Sensor Technology

PASCO's award-winning line of wireless sensors are durably designed, easy to use, and affordably priced to help educators bring real-world technology into the hands of students everywhere. Our wireless sensors feature student-friendly designs, manual and automated data collection, interactive displays and other modern features that enhance science learning. Plus, they connect directly to computers, Chromebooks, tablets, and mobile devices, allowing students to quickly collect data, so they can spend more time analyzing and interpreting their results.

- Original PASCO innovations, such as the //code.Node, Smart Cart, Modular Circuits and Wireless Weather Sensor with GPS
- Award-winning software supports Blockly coding for every sensor
- Onboard sensor memory with Logging Mode for long-term experiments
- Hundreds of free labs available for download from our online Experiment Library
- PASCO-ensured quality and backed by our five-year warranty



Wireless Weather Sensor with GPS

Capable of making 19 measurements and logging GPS data, this all-in-one instrument is ideal for investigating complex environmental conditions.



Wireless Motion Sensor

This sensor measures the position, velocity, and acceleration of objects, and it even includes a 180° rotatable head for creative applications.



Wireless Smart Cart Patent Number 10,481,173

Upgrade to the revolutionary Wireless Smart Cart and start collecting live data for position, velocity, acceleration, force, and rotation directly on your device.



Wireless CO₂ Sensor

Use this sensor to explore respiration and photosynthesis, chemical reactions, and so much more with real-time CO₂ data on your device.



Wireless Colorimeter and Turbidity Sensor

This dynamic sensor simultaneously measures a sample's absorbance and transmittance at six different wavelengths, and it doubles as a turbidity sensor for water quality investigations.



Wireless Temperature Sensor

A staple of every science class, this sensor drastically simplifies temperature measurements with its small footprint, long-lasting battery, and live datalogging.

Our growing line now includes over 30 wireless sensors!



Data Collection and Coding

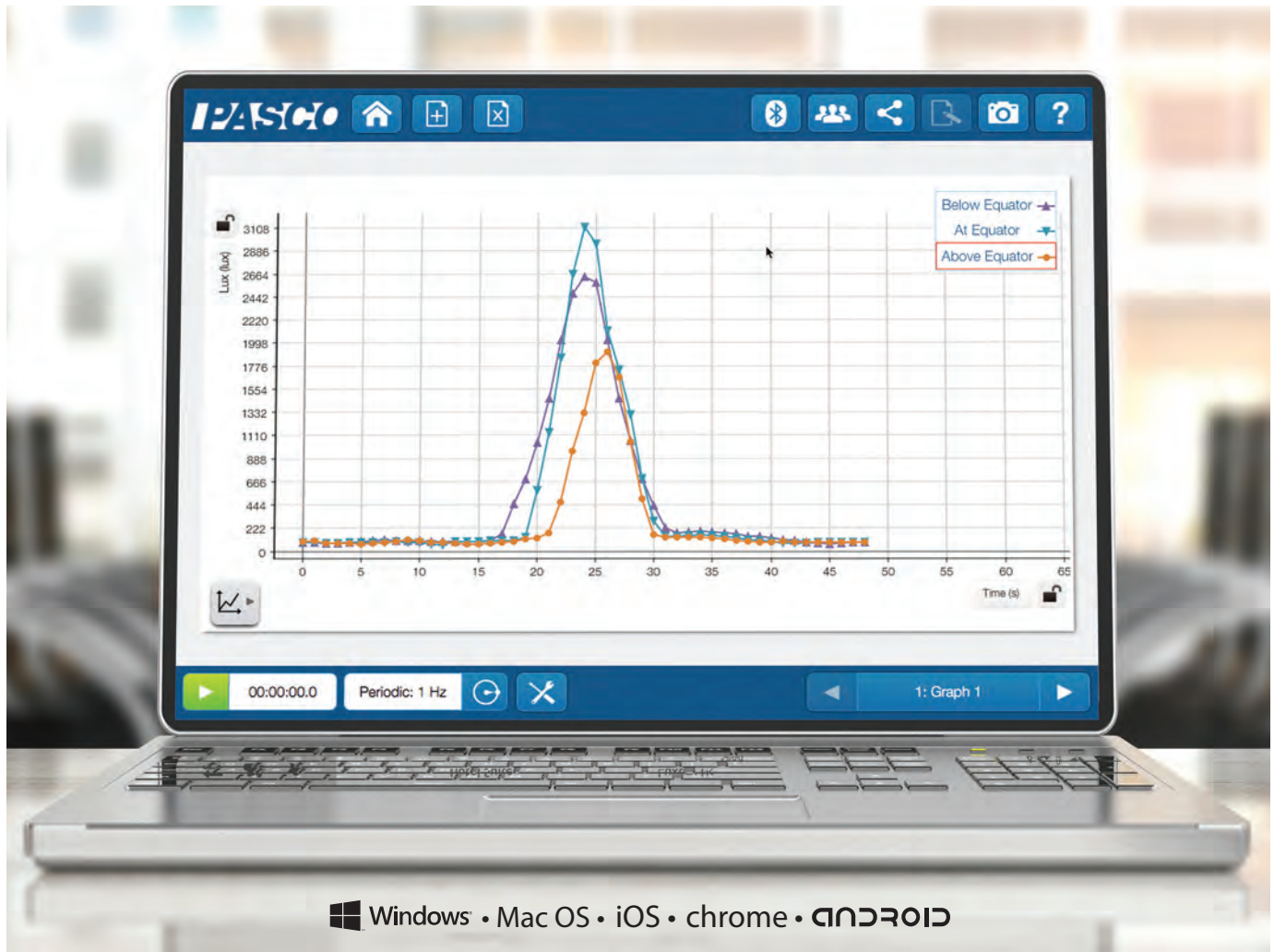

Windows • Mac OS • iOS • chrome • ANDROID



SPARKvue

This award-winning data collection and analysis software works on any platform!

SPARKvue's intuitive design has made it an award-winning tool for collecting and analyzing experimental data. The user-friendly platform optimizes data collection and provides tools for in-depth analysis within a compact, yet powerful workspace.

In SPARKvue 4, we've added new features, including Blockly coding. Now, students can use block-based code to sense and control PASCO devices, including any of our sensors.

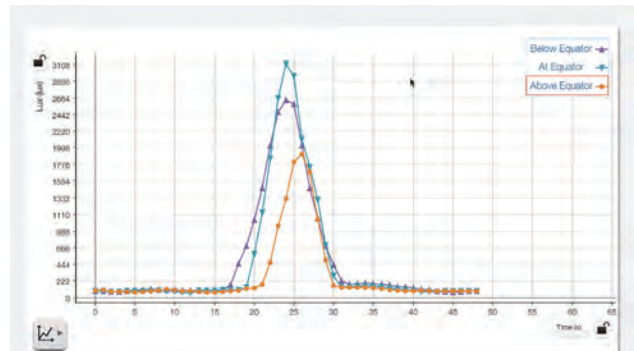

Student Data Collection...**MADE EASY!**

Student-Entered Data & Graphing **MADE EASY!**

Choose manual data collection to record live values with the click of a button.

Make a mistake? No problem! Simply select a data point to replace it.

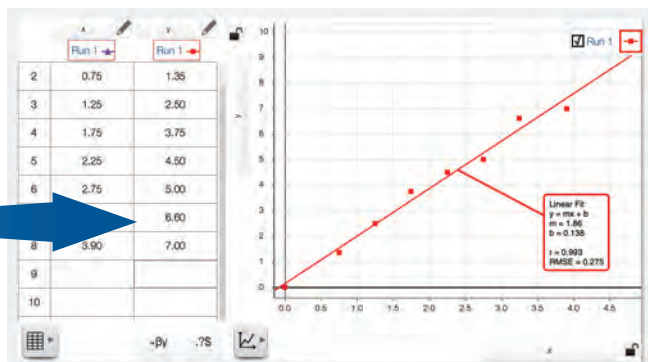
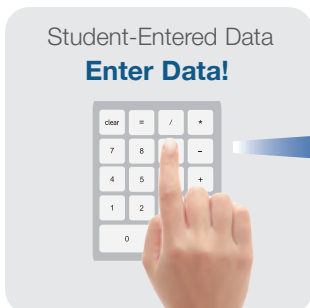

Graph & Analyze Student-Entered Data

Collecting & Graphing Sensor Data **MADE EASY!**

Automate sensor data collection to monitor measurements in real time.

Save time with pre-made experiment files, or build your own with drag-and-drop displays that'll have you up and running in minutes.

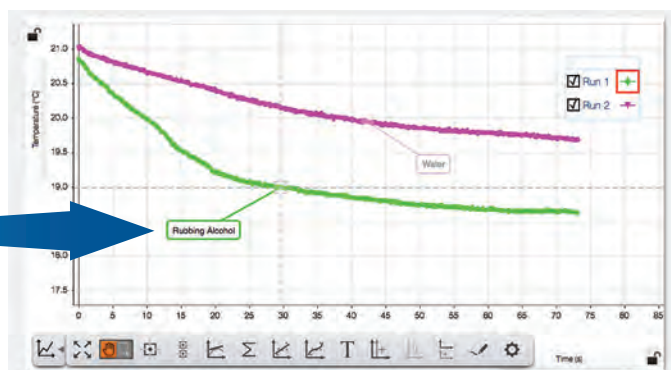

Rapid, Real-Time Data Collection & Analysis



Digits Display



Bar Graph Display



Meter Display



GIS Map Display

Try SPARKvue software for FREE. Get Started Today!

The complete version of SPARKvue is now available as a FREE app for Chromebook™, iPad®, Android™ tablets, and Apple® and Android™ smartphones.

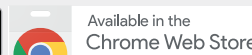

We also offer 30-day free trials for Windows™ and Mac®*. Visit www.pasco.com/downloads

Order Information

SPARKvue Single User License.....PS-2401
SPARKvue Single User License.....PS-2401-DIG

Order Information

SPARKvue Site LicensePS-2400
SPARKvue Site LicensePS-2400-DIG

Complete Lab Stations

PASCO's new Lab Stations make it easy and affordable to begin using sensor-based technology in your science classroom or home.

Elementary Science Starter Lab Station

PS-3314

Inspire a lifelong love of science, while nurturing the development of foundational STEM skills with our new Elementary Science Lab Stations (page 9).



Middle School Science Starter Lab Station

PS-3312

Help prepare your middle school students for high school science with our ready-to-use Middle School Science Lab Stations (page 15).



Biology Starter Lab Station

EB-6334

Make the integration of phenomena-based investigations into your Biology course seamless with our complete Biology Lab Stations. Includes sensors, labs, and more (page 33).



Chemistry Starter Lab Station

EC-6362

Empower students to investigate chemical phenomena like never before with sensors, labs, and apparatus that make chemical concepts more meaningful (page 49).

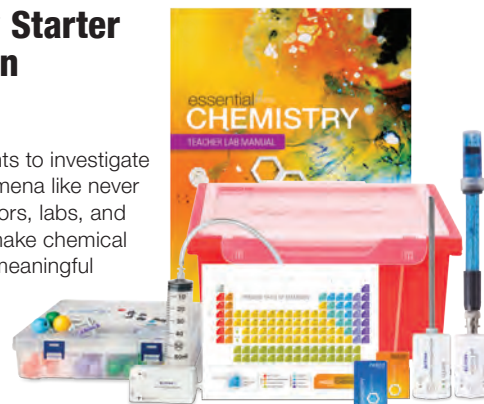

Agricultural Science Starter Lab Station

EB-6336

Transform your classroom into an outdoor field site with our new Agricultural Science Lab Stations. Includes sensors, labs, and more (page 67).



Physics Starter Lab Station

EP-3579

Support hands-on physics learning all year long with our new Physics Lab Stations, complete with sensors, labs, and more (page 79).

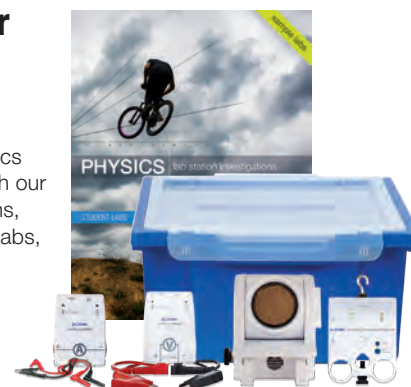

Curriculum Solutions

Essential Physics & Essential Chemistry

(See pages 50 and 84)

PASCO offers two complete curriculum solutions: *Essential Physics* and *Essential Chemistry*. Each program includes a Student Textbook, Student e-Book, Lab Manual, and Equipment Kits, all at a very affordable price. Other program features include:

- Animations and videos
- Flexible assessment options
- Interactive simulations
- Investigations and design challenges



STEM Solutions

Hands-On Coding, Sense and Control Kits

(See pages 18-31)

STEM Sense Kits engage students in the exploration of coding applications with real-world investigations into sensor technologies. Each complete kit includes hands-on, phenomena-based investigations; award-winning data collection and analysis software with block-based coding capability; our unique //code.Node device with programmable sensors, lights and sounds; and all the accessories you need to do the activities. Take student designs to the next level with the all new //control.Node and Sense and Control Kits.



Storage & Classroom Management

Gratnells Rolling Carts, Storage Trays and Charging Stations

(See page 142)

Gratnells storage solutions are the best way to store PASCO sensors and equipment. These movable storage rack carts include large castors with brakes for added stability, and make transporting materials to and from the classroom a breeze.

These carts can be used to store the equipment kits from the *Essential Physics* or *Essential Chemistry* curriculum, the storage trays we offer for wireless sensors, or any of the four sizes of empty trays that we offer for everything else you'd like to store.





PASCO's Hands-on Solutions for K-8 Science

At PASCO, we develop STEM solutions so simple and accessible that even the youngest scientists can use them. Our wireless sensors and engaging activities are the perfect way to introduce K-8 students to inquiry-based discovery learning, without overwhelming them. With our NGSS-based solutions, students of all ages can engage in the active learning process as they navigate their way through hands-on exercises that form lasting STEM foundations.

K-8 Index

Elementary	9
MindLabs.....	12
Middle School.....	14
STEM	18

Elementary Science Starter Lab Station

PS-3314

The Elementary Science Starter Lab Station makes it easy and affordable to begin using sensor-based technology in your elementary school science classroom or home. Inside the Starter Lab Station are the wireless sensors used to perform seven activities from the Essential Elementary Science Lab Manual. Available separately is the Elementary Science Extension Lab Station (PS-3315) which, when combined with the Elementary Science Starter Lab Station, comprises all the wireless sensors used to perform the ten labs inside the Essential Elementary Science Lab Manual. Once comfortable, you can explore our growing set of over 40 elementary labs in our online experiment library!

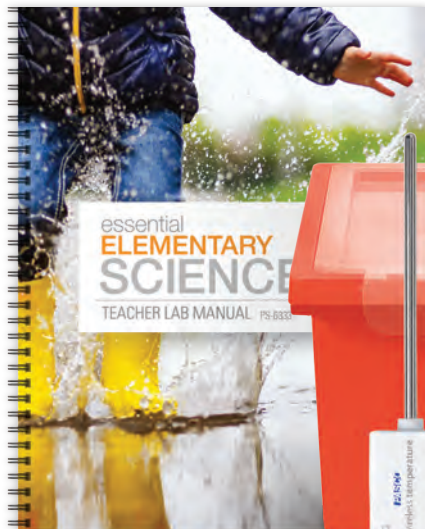

Elementary Science Lab Station with extension sensors

Starter Station Lab Titles (1-7)

1. Temperature and Change
2. Evidence of Chemical Reactions
3. Thermal Insulators and Conductors
4. Can Plants Survive Without Light?
5. How a Greenhouse Works: Heat
6. How a Greenhouse Works: Light
7. MatchGraph

Extension Station Lab Titles (8-10)

8. Determining Sound Levels
9. Weather and Climate: Microclimates
10. Weather and Climate: Monitoring Weather

The Elementary Science Starter Lab Station is a complete solution that includes these wireless sensors and materials:

- ▶ Temperature
- ▶ Light
- ▶ Motion
- ▶ Storage Case
- ▶ Lab Manual

The Elementary Science Extension Lab Station has the additional wireless sensors (Sound PS-3227 and Weather PS-3209) needed to perform all 10 labs inside the Essential Elementary Science Lab Manual.

Order Information

Elementary Science Starter Lab Station	PS-3314
Elementary Science Extension Lab Station	PS-3315



Wireless Temperature Sensor



PS-3201

Welcome to the modern thermometer. The Wireless Temperature Sensor transmits live data and allows students to continuously monitor, log, and plot temperature measurements on nearly any device. When lab-time ends but the experiment continues, students can set the sensor to log data autonomously for days, weeks, or months, then download it for analysis later. This durable, wireless sensor features a stainless steel probe for the most demanding of applications, as well as a battery that lasts over a year*. It can be used in a wide array of experiments and activities because it measures small, but significant temperature changes produced by chemical reactions, convection currents, and even skin temperatures.

Features:

- ▶ Simply pair and go, no cables or adapters to manage
- ▶ Variable sampling rate for capturing small, fast changes or experiments that run for hours, days, or weeks
- ▶ Bluetooth® connectivity and long-lasting coin cell battery
- ▶ Logs temperature data directly onto the sensor for long-term experiments
- ▶ Dust, dirt, and sand-proof and water resistant (IP-X7 certified)



Order Information

Wireless Temperature Sensor.....PS-3201



Wireless Light Sensor



PS-3213

The Wireless Light Sensor features two separate apertures - one for ambient light measurements and one for directional light measurements. The ambient sensor measures illuminance and UV Index, while the spot (directional) aperture measures light level and color intensity. Our software displays the relative intensities of Red, Green, and Blue light, then sums them to determine the level of White light.

Features:

- ▶ Wirelessly connects to computers, Chromebooks, tablets, and smartphones
- ▶ Simply pair and go, no cables or adapters to manage
- ▶ On-board memory enables the sensor to function as an independent datalogger
- ▶ Variable sampling rate for short, precise experiments or lengthy, multi-day data collection.
- ▶ Bluetooth® connectivity and long-lasting coin cell battery

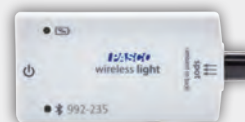

Order Information

Wireless Light SensorPS-3213



Wireless Weather Sensor with GPS

PS-3209

The Wireless Weather Sensor is an all-in-one instrument for monitoring complex environmental conditions. It houses several sensing elements within a single unit to provide 19 different measurements. Use the sensor in logging mode with the Weather Vane Accessory for long-term monitoring, or use it as a handheld instrument to study microclimates and record ambient conditions relevant to environmental phenomena. You can wirelessly export data to your device for classroom analysis and group activities that are constrained by time. With the built-in GPS, you can collect location data for student investigations and analyze it on the map display, powered by ESRI ArcGIS, within SPARKvue software.

Features:

- ▶ Logging mode for long-term experiments
- ▶ Water resistant for extended environmental monitoring
- ▶ Built-in light sensor for measuring light level and UV index
- ▶ Map display (in SPARKvue software) for analyzing spatial data
- ▶ 19 different measurements that can be collected and analyzed individually or simultaneously



Order Information

Wireless Weather Sensor with GPSPS-3209

Wireless Motion Sensor

PS-3219

The Wireless Motion Sensor connects via Bluetooth or USB to your device, and uses ultrasound to measure the position, velocity, and acceleration of objects. This enables students to take turns measuring their own distance from the sensor, while the class observes their motion materializing as a graph in real time. The sensor can detect objects ranging from 15 cm to 4.0 m away, and without cables to get in the way, students can explore handheld and ceiling-mounted applications.

Features:

- ▶ Measures position, velocity, and acceleration
- ▶ False Target Rejection Technology produces cleaner data
- ▶ Clips directly to PASCO Dynamics Tracks
- ▶ Rod clamp for mounting
- ▶ 180° pivoting head
- ▶ Rechargeable Lithium-ion battery
- ▶ Bluetooth® or USB connectivity



FREE MatchGraph! Software

Download Mac®, Windows® and Android™ versions at pasco.com. iOS version available from the Apple App Store.



Order Information

Wireless Motion SensorPS-3219



Playing cards become animated circuits in the app!

Launch Interactive app



TRY IT!

Open the app and select "Create" from the menu. Point your mobile device at the appropriate character card in your card deck.

Build Animated Circuits



Assemble picture cards into working circuits then draw and connect wires on a mobile device to bring circuits to life.

Investigate Concepts



Explore and investigate concepts with step-by-step activities and animated vocabulary and idea cards.



MindLabs

ENERGY and CIRCUITS

FEATURED IN



Forbes



Combines the fun of tabletop games with the excitement of Augmented Reality!

- Student centered, inquiry-based learning
- Aligned with STEM standards
- Includes FREE app and circuit cards
- For 1 to 4 players, ages 8+

Explore energy and circuits through augmented reality, with these interactive playing cards and free app. Includes six sets of twenty cards.

Gooseneck tablet stands free up student hands for interacting with cards and app.



The MindLabs Energy and Circuits Kit is a magical STEM learning tool for children ages 8 and older. It combines 20 game cards, a free digital app, and augmented reality to provide students with a fun and immersive learning experience. Play alone, or collaborate with friends, as you add and remove cards, draw wires, and create circuits that come to life in 3D! The ideal learning tool for solo or team play, MindLabs enables students to explore energy sources, circuits, and more.

- Create, play, and collaborate from any location!
- Assemble cards picturing batteries, light bulbs, fans, and more into working circuits
- Draw and connect wires on a mobile device to bring circuits to life
- Explore forms of energy with animated vocabulary cards
- Investigate energy resources with animated idea cards
- Step-by-step lessons guide students through basic circuit concepts

Features:

- ▶ Work independently or collaborate with students in any location
- ▶ Includes 20 cards and more than 20 interactive challenges with step-by-step guidance
- ▶ Extra thick cards will withstand years of use in your classroom
- ▶ Free application is intuitive and engaging for young learners
- ▶ Five full lesson plans with YouTube video supplements



MindLabs' app is available FREE for Apple® and Android™ tablets and smartphones.



Minimum iOS Requirements: iPhone SE 2016, iPad Mini Gen 5, or iPad 2017 running iOS 11 or later

Minimum Android Requirements: Google Pixel, Samsung S8, Moto Z2, HTC U11, or comparable devices running Android 9 or later



MindLabs Energy and Circuits kits can be purchased individually or in class sets of 6. Gooseneck tablet stands are sold separately for the single set and class sets but 6 gooseneck tablet stands come standard with the Complete Class Set.

MindLabs: Energy & Circuits Single Set.....	SE-7170
MindLabs: Energy & Circuits Class Set.....	SE-7171
MindLabs: Energy & Circuits Complete Class Set .	SE-7172
Gooseneck Tablet Stand.....	SE-7173

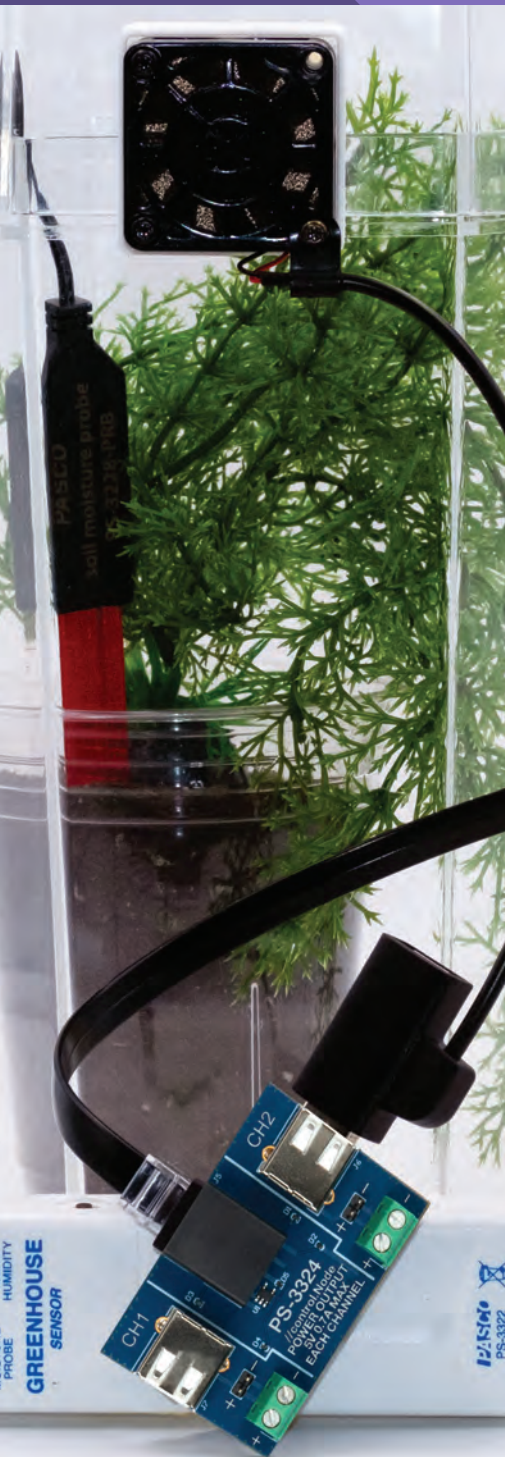

NEW! STEM GREENHOUSE KIT

Explore modern greenhouse technologies with sense and control capabilities. This solution includes all of the sensors, data collection, coding tools, and equipment you need to get started. (See pages 28-29)

Middle School Science Starter Lab Station

PS-3314

The Middle School Science Starter Lab Station makes it easy and affordable to begin using sensor-based technology in your middle school science classroom or home. Inside the Starter Lab Station are the wireless sensors used to perform six activities from the Essential Middle School Science Lab Manual. Available separately is the Middle School Science Extension Lab Station (PS-3313) which, when combined with the Middle School Science Starter Lab Station, comprises all the wireless sensors used to perform all 10 labs included inside the Essential Middle School Science Lab Manual, as well as many of the Middle School labs in PASCO's online experiment library.

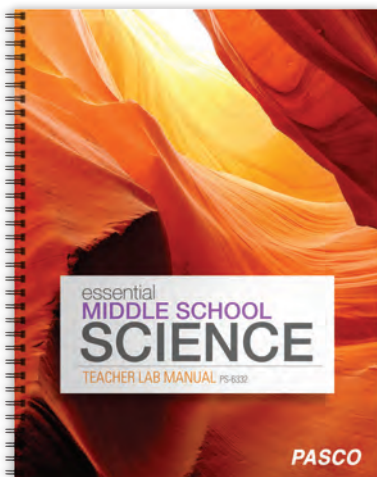

Middle School Science Lab Titles

The Middle School Science Starter Lab Station supports 6 of the 10 labs. Add the Extension Lab Station* to do all 10 lab titles.

1. Describing Motion

2. Humidity and Dew Point*

3. Night and Day

4. Seasons and Temperatures



5. Thermoregulation

6. Introduction to Acids

7. Photosynthesis*

8. Acid Rain and Weathering

9. Forces and Interactions*

10. Waves and Energy*



Middle School Science Lab Station with extension sensors

The Middle/Secondary School Science Starter Lab Station includes these wireless sensors and materials:

- ▶ Temp
- ▶ Light
- ▶ pH
- ▶ Motion
- ▶ Storage Case
- ▶ Lab Manual

The Middle School Science Extension Lab Station has the additional wireless sensors (CO₂ PS-3208 and Weather PS-3209) needed to perform all 10 labs inside the Essential Middle School Science Lab Manual.

Order Information

Middle School Science Starter Lab StationPS-3312

Middle School Science Extension Lab Station.....PS-3313

Wireless Sound Sensor

PS-3227

The Wireless Sound Sensor is two sensors in one wireless package: a sound wave sensor capable of measuring changes in relative pressure level as a function of time, and a sound level sensor with both dBA and dBC-weighted scales.

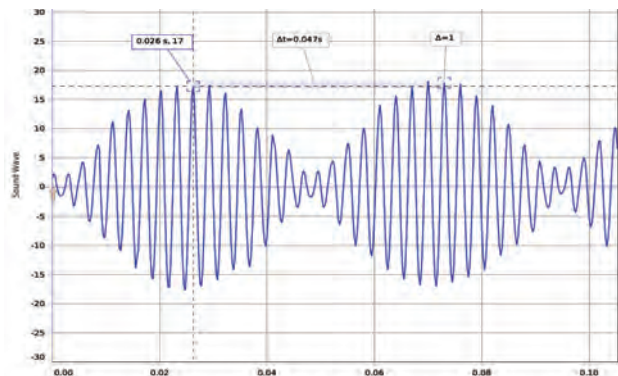

Easily observe and measure beat frequencies

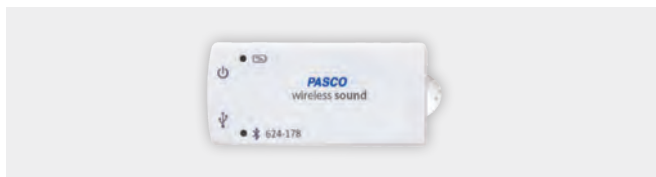

Order Information	
Wireless Sound Sensor	PS-3227

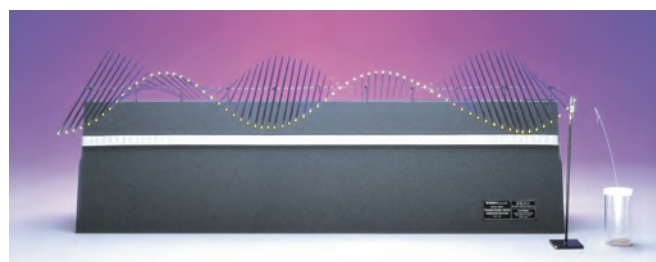

Single Section Wave Motion Demonstrator

SE-9601

The Single Section (Transverse) Wave Motion Demonstrator uses mechanical waves to illustrate many of the properties and behaviors common to various types of waves. For example, the user can explore how the velocity, frequency, and the wavelength interact in the mathematical modeling relationship. Also, the user may readily visualize the superposition of waves, and easily study resonance conditions that cause standing waves

Order Information	
Single Section Wave Motion Demonstrator	SE-9601

Wireless Light Sensor

PS-3213

The Wireless Light Sensor features two separate apertures - one for ambient light measurements and one for directional light measurements. The ambient sensor measures illuminance and UV Index, while the spot (directional) aperture measures light level and color intensity. Our software displays the relative intensities of Red, Green, and Blue light, then sums them to determine the level of White light. The light available to drive photosynthesis (PAR) and total light power per area (irradiance) are also available as calculated measurements within PASCO Capstone (version 1.8 or later) and SPARKvue software (version 2.6 or later).

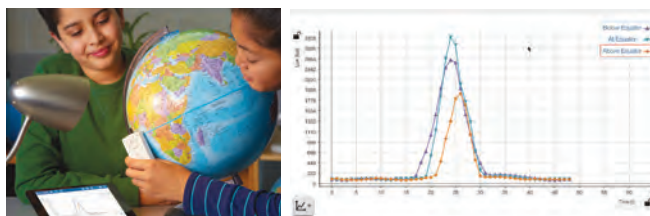

Order Information	
Wireless Light Sensor	PS-3213

Color Mixer

OS-8496

Three independently controllable LEDs offer a simple way to explore light and color. The Color Mixer can be used as both a demonstration tool and as an expansion piece to the Basic Optics System.

The intensity of the red, green and blue LEDs of the Color Mixer can be individually adjusted to easily vary the intensity of any or all of them. Demonstrating additive color mixing is as simple as using any flat surface to project the light upon.



Use as a projector in classroom demonstrations. Individually adjust the intensity of the super bright red, green, and blue LEDs.



Order Information	
Color Mixer	OS-8496

Wireless Motion Sensor

PS-3219

The Wireless Motion Sensor connects via Bluetooth or USB to your device, and uses ultrasound to measure the position, velocity, and acceleration of objects. This enables students to take turns measuring their own distance from the sensor, while the class observes their motion materializing as a graph in real time. The sensor can detect objects ranging from 15 cm to 4.0 m away, and without cables to get in the way, students can explore handheld and ceiling-mounted applications.

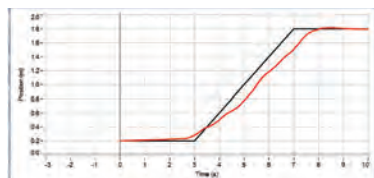

FREE MatchGraph! Software

Download Mac®, Windows® and Android™ versions at pasco.com. iOS version available on Apple App Store.



Order Information

Wireless Motion SensorPS-3219

Wireless Force Acceleration Sensor

PS-3202

Capable of simultaneously measuring force, acceleration, and rotational velocity, this sensor is ideal for experiments involving rotating platforms, moving carts, spring oscillations, collisions, and impulse. The wireless design offers improved measurement accuracy by eliminating cords that affect data collection. Students can use the finger-holes for handheld applications, or mount it onto a cart or rod for more complex experiments.



The Wireless Force Acceleration Sensor is perfect for explorations of Newton's 3rd Law.

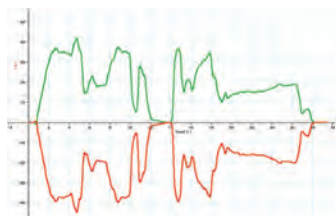

Order Information

Wireless Force Acceleration Sensor.....PS-3202



Smart Cart (Red & Blue)

ME-1240/ME-1241

The patented Smart Cart is the ultimate tool for studying kinematics, dynamics, Newton's Laws, and more. It is based on a durable ABS body with nearly frictionless wheels, just like our high quality PAScars. Now, we've added built-in sensors that measure force, position, velocity, and acceleration. The versatile Smart Cart can collect measurements on or off a track and transmit the data wirelessly over Bluetooth. In essence, it is a wireless dynamics cart that combines all the necessary sensors, without requiring any additional hardware.

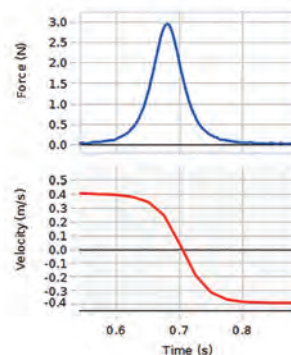

Order Information

Smart Cart (Red)ME-1240

Smart Cart (Blue)ME-1241

Constant Speed Buggy

SE-8028A

Turn on the Constant Speed Buggy and watch it go. When it reaches a wall, it flips over and changes directions. This low-cost solution features flashing lights and a sporty appearance. Requires two "C" batteries that are not included. Actual product may vary from picture.



Order Information

Constant Speed Buggy.....SE-8028A

Wireless Temperature Sensor

PS-3201

Welcome to the modern thermometer. Now, students can access real-time data that continuously monitors, logs, and plots temperature measurements on nearly any device. When lab-time ends but the experiment continues, students can set the sensor to log data autonomously for days, then download it for analysis later. This durable, wireless sensor features a stainless steel probe for the most demanding of applications, as well as a battery that lasts up to a year. It can be used in a wide array of experiments and activities because it measures small, but significant temperature changes produced by chemical reactions, convection currents, and even skin temperatures.



Order Information

Wireless Temperature Sensor.....PS-3201

Wireless pH Sensor

PS-3204

The Wireless pH Sensor is a must-have for any chemistry, biology, or environmental science course. Equally capable in the lab or field, the sensor eliminates the hassle of cables, reducing spills and improving safety. Plus, it rarely requires charging; the sensor's coin cell battery lasts for 2-3 years in most labs and costs about one dollar to replace. It can transmit data in real time, or store data for days when continuous monitoring is required. The Wireless pH Sensor enhances countless activities, including acid-base titrations, investigations into household chemicals, analyses of chemical reactions, water quality studies, and much more.



Order Information

Wireless pH Sensor.....PS-3204

Wireless CO₂ Sensor

PS-3208

Measure changes in carbon dioxide (CO₂) gas levels quickly and easily with the Wireless CO₂ Sensor. The sensor is temperature compensated and can operate in high humidity environments, like the included 250-mL sample bottle. This sensor employs live data to make core labs, such as photosynthesis, cellular respiration, and metabolism experiments engaging and impactful. With the ability to store more than 55,000 data points, this sensor enables studies to run overnight or throughout an entire weekend for long-term carbon cycling investigations.

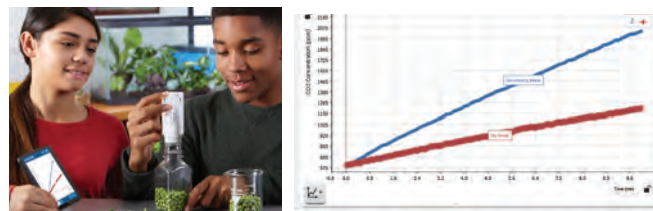

Order Information

Wireless CO₂ Sensor.....PS-3208

Wireless Weather Sensor with GPS

PS-3209

The Wireless Weather Sensor is an all-in-one instrument for monitoring complex environmental conditions. It houses several sensing elements within a single unit to provide 19 different measurements. Use the sensor in logging mode with the Weather Vane Accessory for long-term monitoring, or use it as a handheld instrument to study microclimates and record ambient conditions relevant to environmental phenomena.



Order Information

Wireless Weather Sensor with GPSPS-3209
Weather Vane AccessoryPS-3553

STEM SENSE SOLUTIONS



STEM Sense solutions help build early excellence in science and STEM education with cross-curricular investigations that help learners build strong foundations in science, programming, and data literacy. Each complete kit includes an easy-to-use coding device; award-winning software with Blockly coding; hands-on, phenomena-based investigations; and all the equipment and supplies students need to complete the investigations.

STEM Sense Kits include investigations with video lessons, printed student worksheets, and access to an interactive digital flipbook that presents the resources in a student-friendly format.



Coding With Sensor
Technologies Kit



Coding With Vehicle Sensor
Technologies Kit

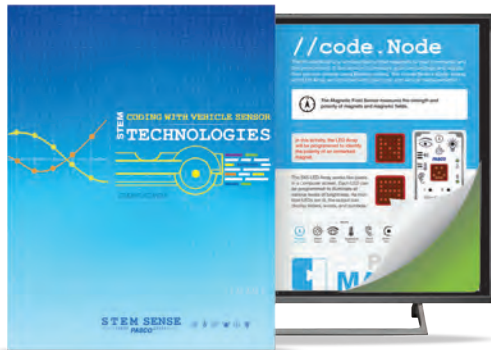

Student Activities, Video Lessons & Online Flipbook

STEM Sense Kits include investigations with video lessons, printed student worksheets, and access to an interactive flipbook that presents the resources in an engaging, student-friendly format. Each lesson is based upon the latest science standards and incorporates cross-curricular connections to reinforce key concepts in computer science, mathematics and language arts.

SPARKvue + Block-Based Programming

SPARKvue offers all the benefits of a visual coding environment with additional features for data collection, visualization and analysis. When students execute a program in SPARKvue, they can monitor sensor data collection in real time, displaying it in digits, graphs and/or text. Students can also combine PASCO sensors and coding devices, such as the //code.Node, to create programs that interact with the physical world. With PASCO and Blockly, young students can learn how to create, modify, and execute block-based coding programs, while developing the skills they'll need to progress on to traditional text programming languages like Java, Python, and C++.



Coding & Control Devices + Equipment

The //code.Node and //control.Node bridge the gap between science and computer science to provide students with hands-on learning opportunities that promote literacy in science, programming and data collection. All PASCO coding devices integrate with our sensors and data collection and coding software, enabling students to perform basic coding with technology activities as well as more advanced sense and control investigations. STEM Sense Kits come ready-to-use with all the additional equipment and supplies required to do the activities, including magnets, tuning forks, the //code.Node Cart, the PASCObot, and much more.



Coding With Sound & Light
Sensor Technologies Kit



PASCObot Sense &
Control Kit



Greenhouse Sense &
Control Kit

SPARKvue & Blockly Coding: Computational Thinking Meets Data Literacy

The Integration of Blockly into SPARKvue software provides science and STEM teachers with an intuitive coding platform that fits their needs. Rather than introducing students to coding independently, Blockly integrates computational thinking into the exploration of phenomena to provide learners with a new world of STEM opportunity.

With Blockly, students can create custom data collection parameters, feedback loops, data displays, and so much more.

Use Blockly in SPARKvue to:

- Introduce students to computational thinking
- Investigate phenomena while learning to code
- Create data-driven feedback loops
- Program data collection parameters for any PASCO sensor or interface

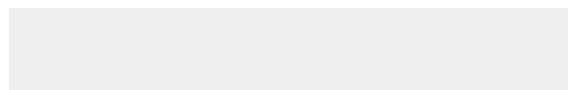

The desktop monitor displays the SPARKvue Blockly editor. The code includes:

```

Code
Code execution enabled
Blockly Lua
Logic
Loops
Math
Text
Lists
Variables
Functions
Hardware
Code Output
Time
Notes

set requiredChange to 0.2
set heatRelease to value of Temperature °C + requiredChange
set heatAbsorption to value of Temperature °C - requiredChange
repeat while true
do
  sleep for 500 ms
  if value of Temperature °C
  do
    in text output energy transfer enter
  else if value of Temperature °C
  do
    in text output energy transfer enter
  else
    in text output energy transfer enter
  
```

The laptop displays a data table and a graph. The data table is as follows:

Temperature (°C)	heat transfer	Notes
115	20.1	Endothermic Reaction
116	20.2	Endothermic Reaction
117	20.1	Endothermic Reaction
118	20.1	Endothermic Reaction
119	20.1	Endothermic Reaction
120	20.1	Endothermic Reaction
121	20.1	Endothermic Reaction
122	20.1	Endothermic Reaction
123	20.1	Endothermic Reaction
124	20.1	Endothermic Reaction
125	20.1	Endothermic Reaction
126	20.1	Endothermic Reaction

The graph shows Temperature (°C) on the y-axis (ranging from 20.0 to 20.5) and Time on the x-axis. A blue line shows a sharp drop in temperature from approximately 20.2°C to 20.0°C, followed by a gradual recovery. A red box highlights a data point on the graph.

Create code that collects, displays, and responds to sensor data! Interact with the physical world using the PASCO //code.Node or //control.Node.

Support computational thinking in science with ready-to-use Blockly extension activities.

Try SPARKvue with Blockly for FREE. Get Started Today!

The complete version of SPARKvue is now available as a FREE app for Chromebook™, iPad®, Android™ tablets, and Apple® and Android™ smartphones.



Available in the
Chrome Web Store



We also offer 30-day free trials for Windows™ and Mac®.*
Visit www.pasco.com/downloads

This award-winning data collection and analysis software now includes Blockly coding with data displays!

Getting started with //code.Node is quick and easy. Simply connect the //code.Node to SPARKvue and begin coding instructions for its sensor inputs and device outputs. As the code is executed, SPARKvue displays real-time data from the //code.Node's active sensors, which triggers a response from the //code.Node's lights and sounds. Other PASCO sensors may also be used in Blockly programs, enabling students to explore a new world of opportunity.



Explore more advanced coding applications with the //control.Node.

CODING IN SPARKVUE

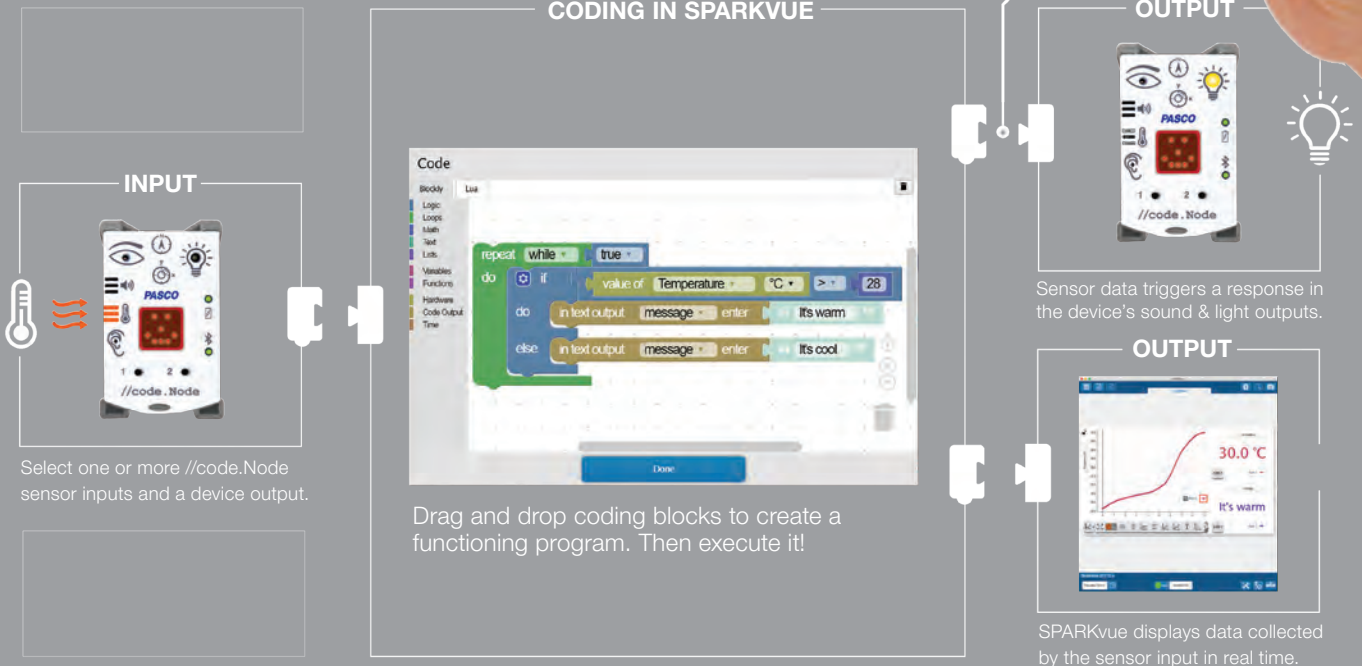

Select one or more //code.Node sensor inputs and a device output.

Drag and drop coding blocks to create a functioning program. Then execute it!

Sensor data triggers a response in the device's sound & light outputs.

SPARKvue displays data collected by the sensor input in real time.

Order Information

- SPARKvue Single User License.....PS-2401
- SPARKvue Single User License.....PS-2401-DIG

Order Information

- SPARKvue Site LicensePS-2400
- SPARKvue Site LicensePS-2400-DIG

HELLO

Meet //code.Node!

The //code.Node is a hands-on coding device with interactive sensors, lights, and sounds that make learning to code a real-life STEM adventure. Designed for ages eight to fourteen, the //code.Node helps kids harness their natural curiosity to create block-based programs that bring their ideas to life.

Whether they're interested in cars, robots, sports or science, //code.Node allows kids to explore the things they love through coding. Together, the //code.Node, interactive Flipbooks, and step-by-step video lessons enable new coders to master the basics at their own pace, while the accessories and wrist-strap ensure confident coders never run out of possibilities.

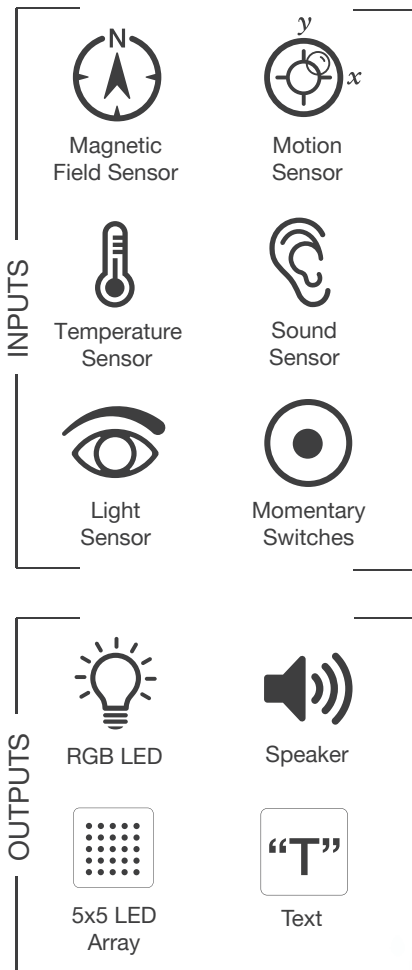

Order Information

//code.Node.	PS-3231
//code.Node Holder.....	PS-3233
//code.Node (Set of 8)	PS-3311



Coding with Sensor Technologies Kit

ST-7800

The Coding with Sensor Technologies Kit introduces students to coding and includes ten hands-on investigations that explore science phenomena using the //code.Node's programmable sensors, lights and sounds.

Student Activities and Video Lessons

The Coding with Sensor Technologies Kit includes ten investigations with video lessons, printed student worksheets, and an interactive digital flipbook that presents the resources in an engaging, student-friendly format. Each lesson is based upon the latest science standards and incorporates cross-curricular connections to reinforce key concepts in computer science, mathematics and language arts.

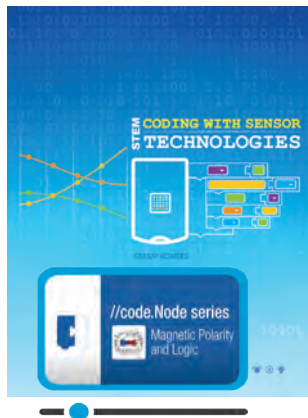

Activities and Video Lessons

- ▶ Magnetic Polarity
- ▶ Random Number Cube
- ▶ Automatic Nightlight
- ▶ Light Bulb Efficiency
- ▶ Clap On
- ▶ What's the Origin?
- ▶ Investigating Sound Levels
- ▶ Step Counter
- ▶ Intruder Alarm
- ▶ Digital Thermometer

Build career awareness with activities that make real-world connections to:

- ▶ Engineering with real-life sensors
- ▶ Designing "smart" home technology
- ▶ Programming and developing sensor-based safety features

Help students develop competency in:

- ▶ Problem-solving, logical reasoning and critical thinking
- ▶ Computational thinking
- ▶ Data collection and analysis
- ▶ Mathematics
- ▶ Technology and programming



Block-Based Coding

Blockly simplifies the programming process for new coders. Visual coding blocks connect like puzzle pieces to help students master the basics of programming, without having to worry about their syntax.

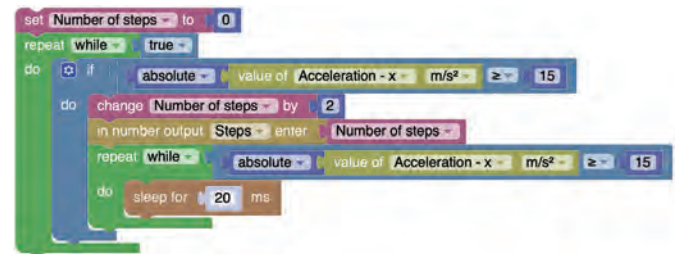

Coding with Sensor Technologies Equipment

The Coding with Sensor Technologies Kit includes a //code.Node, two painted bar magnets, and a //code.Node Holder with wrist-strap. Wireless and easy-to-use, the //code.Node includes six sensor inputs, a speaker, RGB light, and an LED Array that enable students to explore exciting phenomena using block-based programs that collect, display and respond to data.



Includes:

- //code.Node PS-3231
- //code.Node Holder PS-3233
- Painted Bar Magnet (Pair) SE-7593
- Color-Printed Booklet of Student Activities

Order Information

Coding with Sensor Technologies Kit.....ST-7800



Coding with Vehicle Sensor Technologies Kit

ST-7820

Explore the science and sensors behind today's modern vehicles, while teaching students about physical science as they design, test, measure and code with sensors that mimic real-world vehicle technology.

Student Activities and Video Lessons

This complete kit includes five investigations with video lessons, printed student worksheets, and an interactive, browser-based flipbook that presents the resources in an engaging, student-friendly format. Each lesson is based upon the latest science standards and incorporates cross-curricular connections to reinforce key concepts in computer science, mathematics and language arts.



Activities and Video Lessons

- ▶ **Crash Test:** Impact Alert System
- ▶ Investigating Odometers
- ▶ Engineering Turn Signals
- ▶ 3-2-1 Launch!
- ▶ **The Need for Speed:** Radar Detectors



Build career awareness with activities that make real-world connections to:

- ▶ Automotive engineering
- ▶ Real-life vehicle sensors
- ▶ Crash test engineering

Help students develop competency in:

- ▶ Problem-solving, logic, and critical thinking
- ▶ Computational thinking
- ▶ Data collection and analysis
- ▶ Mathematics
- ▶ Technology and programming



Block-Based Coding

Blockly simplifies the programming process for new coders. Visual coding blocks connect like puzzle pieces to help students master the basics of programming, without having to worry about their syntax.

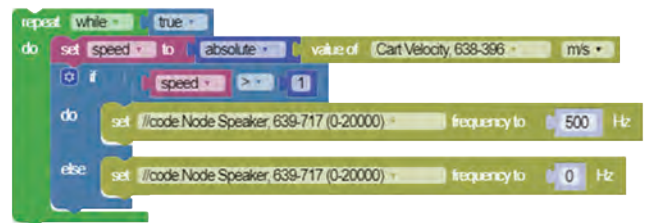

Coding with Vehicle Sensor Technologies Equipment

The Coding with Vehicle Sensor Technologies Kit comes classroom-ready with all the equipment, accessories, and software needed to complete the included activities. The complete kit includes a //code.Node; a //code.Node Cart; a color-printed booklet of student activities; two light spring bumpers; six 50-g masses; a 1.5-m roll of measuring tape; a spool of thread; and two block person figurines.



Includes:

- //code.Node PS-3231
- //code.Node Cart PS-3235
- Color-Printed Booklet of Student Activities
- Light Spring Bumpers (Qty. 2)
- 50 g Masses (Qty. 6)
- Soft Measuring Tape, 1.5m
- Spool of Thread
- Block Person Figurines (Qty. 2)

Order Information

Coding with Vehicle Sensor Technologies KitST-7820



Coding with Sound and Light Sensor Technologies Kit

ST-7830

The Coding with Sound and Light Sensor Technologies Kit engages students in the exploration of light and sound with five hands-on coding investigations that use familiar phenomena and real-world sensors to bring concepts to life.

Student Activities and Video Lessons

This complete kit includes five investigations with video lessons, printed student worksheets, and an interactive, browser-based flipbook that presents the resources in an engaging, student-friendly format. Each lesson is based upon the latest science standards and incorporates cross-curricular connections to reinforce key concepts in computer science, mathematics and language arts.

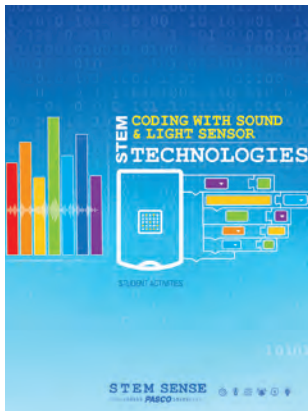

Activities and Video Lessons

- ▶ What is a Color Sensor?
- ▶ **RGB LED:** How to Program Color
- ▶ Engineering Sound Level Meters
- ▶ **Detect an Intruder:** Home Alarm Systems
- ▶ Investigating Electronic Tuners

Build career awareness with activities that make real-world connections to:

- ▶ Audio engineering and light technicians
- ▶ Programming and developing sensor-based security features
- ▶ Real-world innovations in sound and light technology

Help students develop competency in:

- ▶ Problem-solving, logic, and critical thinking
- ▶ Computational thinking
- ▶ Data collection and analysis
- ▶ Mathematics
- ▶ Technology and programming



Block-Based Coding

Blockly simplifies the programming process for new coders. Visual coding blocks connect like puzzle pieces to help students master the basics of programming, without having to worry about their syntax.

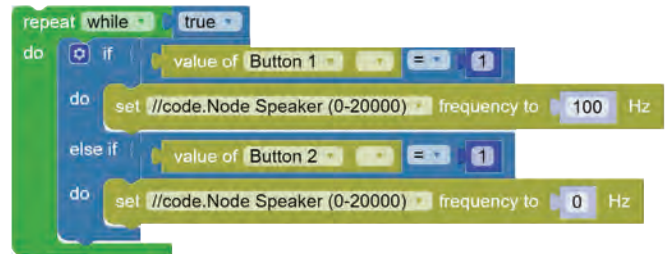

Coding with Sound and Light Sensor Technologies Equipment

The Coding with Sound and Light Sensor Technologies Kit includes everything students need to explore concepts in light and sound through STEM. The complete kit includes: a //code.Node; a //code.Node Holder with wrist-strap; two tuning forks of different frequencies; a small flashlight; a color-printed booklet of student activities; a set of colored paper; and five sheets of aluminum foil.



Includes:

- //code.Node PS-3231
- //code.Node Holder PS-3233
- Color-Printed Booklet of Student Activities
- Small Flashlight
- Tuning Fork, Various Frequency (Qty. 2)
- Colored Paper, Various 4"x4" Sheets (Qty. 35)
- Aluminum Foil Sheet, 4"x4" Sheets (Qty. 5)

Order Information

Coding with Sound and Light Sensor Technologies Kit ST-7830

INTRODUCING
PASCObot





Build career awareness with activities that make real-world connections to:

- ▶ Automotive engineering
- ▶ Innovations in self-driving vehicles
- ▶ Risk mitigation through engineering and design

Block-Based Coding

Blockly simplifies the programming process for new coders. Visual coding blocks connect like puzzle pieces to help students master the basics of programming, without having to worry about their syntax.

PASCObot Equipment

The PASCObot comes with all the materials needed to build, program, and control the PASCObot. Simple to build and easy to program, the PASCObot consists of just seven pieces, including a PASCObot Body, two Wheels, two Stepper Motors, and a rechargeable //control.Node that enables students to execute their code in real time or store it onboard for execution later.

Includes:

- PASCObot Body
- //control.Node
- 2 Stepper Motors
- 2 Wheels
- Student activities (digital)

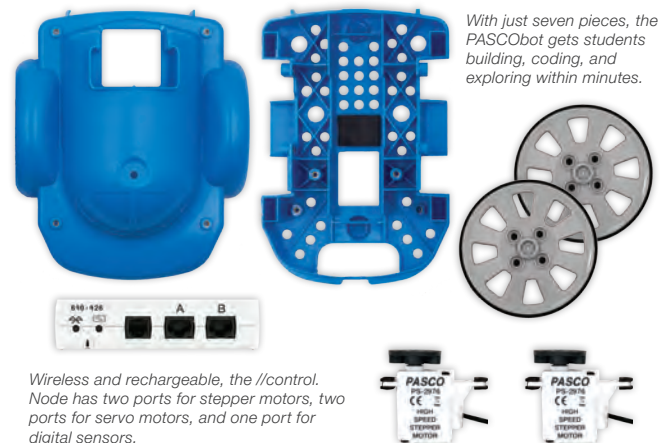

Order Information

PASCObotPS-2994

PASCObot

PS-2994

The PASCObot helps harness students' interest in robotics to drive deeper learning in science and STEM. With scaffolded activities and plenty of room for personalization, the PASCObot opens a new world of opportunity for students to grow, create, and even compete! This kit includes all the materials needed to build, program, and control the PASCObot.

Student Activities

The PASCObot is supported by student activities that cover everything from coding the robot's first movements to navigating it through a custom obstacle course. Once they've mastered the basics, students can continue their journey by creating their own Blockly programs, PASCObot challenges, and head-to-head competitions.



Student Activities

- ▶ Navigating a simple maze
- ▶ Object Avoidance
- ▶ Line following
- ▶ Line following with objects
- ▶ Adjusting speed on an incline
- ▶ Locating, Gripping, and moving objects

Help students develop competency in:

- ▶ Coding
- ▶ Mathematics
- ▶ Computational thinking
- ▶ Collaborative problem solving
- ▶ Engineering and Design practices

PASCObot

SENSE & CONTROL KIT

When nestled inside the PASCObot, the //control.Node serves as a brain, providing both power to the bot and memory storage for students' code.



Build your bot in minutes with simple components and connector pieces that bring power to its wheels.

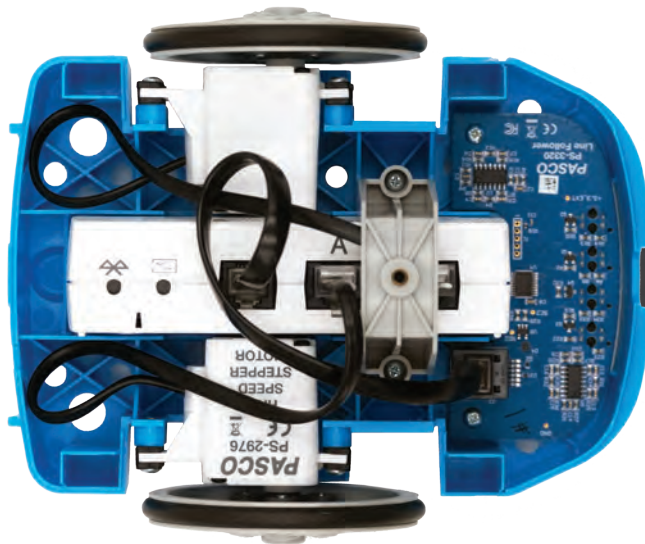

Navigate custom paths, obstacles, and more with code blocks that drive the bot forwards, backwards, or around corners and curves.



Create programs that control how the PASCObot identifies and responds to objects! Pick up a can, stack cups, or avoid objects entirely with the included Range Finder.

Stream code to the bot in real time or use the rechargeable //control.Node to run programs autonomously!

Designed for ages 11+, the PASCObot Sense & Control Kit includes everything students need to explore STEM through coding and robotics. Whether they're new programmers or hobby hackers, the PASCObot makes it easy to support students of all levels with a variety of scaffolded and open-ended activities.

This complete kit includes a PASCObot and //control. Node, as well as all the accessories needed to program how the bot interacts with its environment. From simple movements and spins to object avoidance to complex obstacle courses, there's no limit to what students can create with PASCObot.

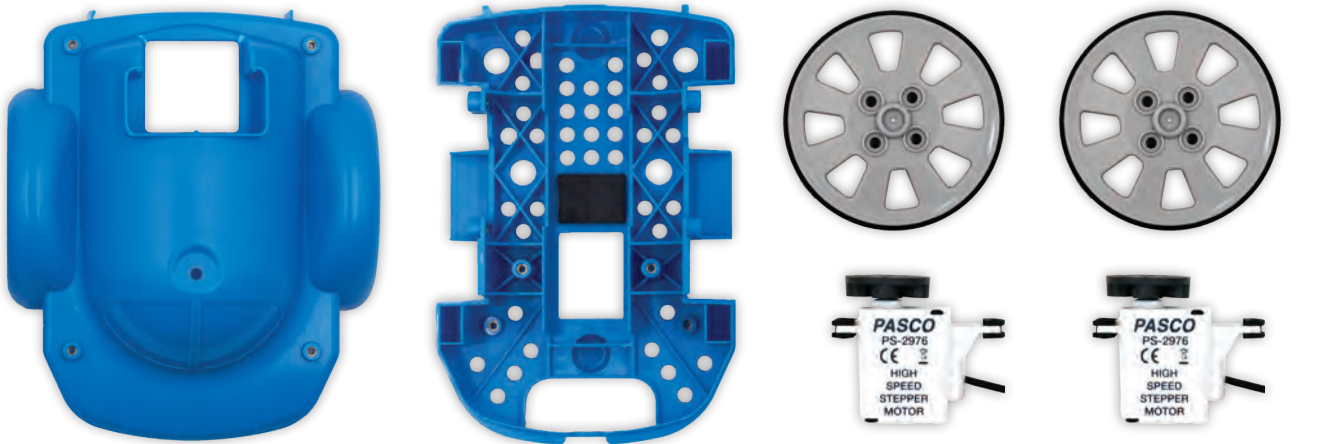

The PASCObot's motion is controlled by two Stepper Motors, which connect to the bot's Wheels. Compatible with other STEM Sense products, the Stepper Motors can be controlled individually to move the bot forwards, backwards, and around corners and curves.

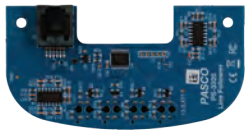

The Line Follower enables the PASCObot to detect and respond to custom line paths that students create using the included tape.



The Range Finder gives the PASCObot sight, allowing it to locate, avoid, and respond to objects based on code.



Wireless and rechargeable, the //control. Node has two ports for stepper motors, two ports for servo motors, and one port for digital sensors.



Design custom obstacle courses using the included cups and tape. Then create code to navigate the bot through the course!

The PASCObot Gripper Accessory opens a new world of opportunity by enabling students to program the bot to move, pick up, or even stack a variety of objects. When used with the included Range Finder, the PASCObot Gripper Accessory allows students to control how the bot identifies and interacts with objects.

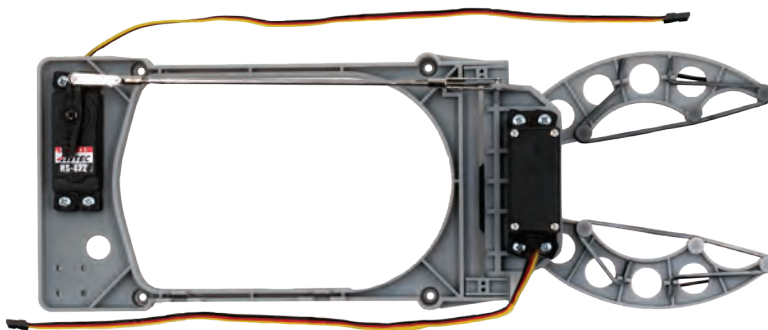

Order Information

PASCObot Sense & Control KitST-7840

The PASCObot Sense & Control Kit comes with the PASCObot (body, wheels, stepper motors and //control.Node) and all of the modules and accessories shown above. See below and right for à la carte ordering.

PASCObot Line Follower ModulePS-3320

PASCObot Range Finder Module.....PS-3321

Order Information

PASCObot Gripper AccessoryPS-3325.

PASCObot Servo MotorSE-2975

Black and White Tape (rolls)SE-2953

Small Plastic Cup Set (5 colors)SE-2952



Greenhouse Sense & Control Kit

ST-2997

Designed for the exploration of biological and ecological concepts, the Greenhouse Sense & Control Kit includes everything students need to design, build, program, and study their very own greenhouse.

Student Activities

The Greenhouse Sense & Control Kit includes five student activities that can be edited to fit your course needs. Each activity focuses on a key concept in biology or environmental science and includes extensions to engineering and design practices.



Student Applications

- ▶ Investigate the effects of various wavelengths of light on plant growth using the programmable Red and Blue Grow Light.
- ▶ Explore the role of wind to control temperature and humidity with the controllable fan.
- ▶ Research a plant species to recreate its natural habitat inside the EcoChamber.

Build career awareness with activities that make real-world connections to:

- ▶ Agricultural monitoring
- ▶ Ecological management
- ▶ Plant physiology

Help students develop competency in:

- ▶ Coding
- ▶ Problem solving
- ▶ Data collection and analysis
- ▶ Ecological concepts
- ▶ Science and Engineering practices



Block-Based Coding

The Blockly integration within SPARKvue software makes it easy for students to master the basics of programming, without having to worry about their syntax. Rather than overwhelming students with options, Blockly focuses on building coding literacy through a library of customizable, drag-and-drop coding blocks.

As they combine coding blocks, students are provided with visual feedback that let's them know whether two coding blocks are compatible. After mastering the basics, students can go on to create their own programs, complete with custom conditions, commands, data displays, and more. With Blockly and STEM Sense, students can pursue all types of investigations - from single-day experiments to semester-long studies.

Greenhouse Sense & Control Kit Equipment

This complete kit includes: an EcoChamber and //control.Node; a breakout board; a fan; a water pump; tubing with drip-watering ends; a red and blue grow light; and a Greenhouse Sensor that measures light, temperature, humidity, and soil moisture.



Order Information

Greenhouse Sense & Control Kit.....ST-2997

Create your own ecosystem, optimize growth, and more!

Hassle-free ports make it easy to mix and match sensors, while also permitting gas exchange.

Plug your own devices into the included Breakout Board to extend your investigations.

Use data from the Soil Moisture Probe to optimize watering schedules for specific species and microhabitats.

Make data-based decisions with measurements for humidity, temperature, light, and soil moisture.

Ideal for studies in biology, environmental science, and STEM, the Greenhouse Sense & Control Kit comes fully customizable, enabling students to explore countless interactions between plants and environmental factors.

Support authentic science practices, while conserving time with automated sensor measurements that make daily observations quick and easy.

Investigate the effects of temperature, humidity, and wind disturbance.

Design a water source, complete with pump, and control it using code!



The //control.Node serves as the Greenhouse's brain, providing power to the light, fan, water pump, and sensors!

Potential topics of study include soil moisture, humidity, temperature fluctuations, light availability, inter- and intraspecies competition, wind disturbance, and so much more.



PASCO's Hands-on Solutions for Your Biology Lab

PASCO offers dynamic educational solutions for General, AP®, IB®, and Honors Biology courses. Our Wireless Sensors facilitate hands-on engagement and help students develop data analysis skills, while our labs provide inquiry-based planning support. Using PASCO's SPARKvue software, sensors, and lab experiments, students can deeply explore topics such as photosynthesis, cellular respiration, enzyme reactions, human physiology, spectrometry, and more.

Biology Index

Biology Starter Lab Station	33
Advanced, AP & IB Biology	34
Weather with GPS and Soil Moisture.....	36
Temperature and pH.....	37
Conductivity and Pressure.....	38
Light, Diffusion/Osmosis	39
CO ₂ and O ₂	40
Optical Dissolved Oxygen and Photosynthesis Tank..	41
EcoZone System and Colorimeter/Turbidity.....	42
Wireless Spectrometer and UV-VIS Spectrometer	43
Hand-Grip & Exercise Heart Rate, Blood Pressure	44
Spirometer and EKG	45
Airlink Interface and Human Arm Model	46
Human Eye Model and Digital Microscopes	47

World Class Support & Professional Development

Committed to Your Success

We want you to have all the support, guidance, and training you need. Just let us know how we can help.

CONTACT US TODAY
pasco.com

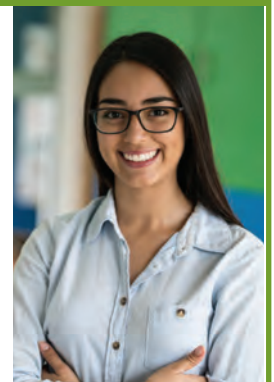

Biology Starter Lab Station

EB-6334

The Biology Starter Lab Station makes it easy and affordable to begin using sensor-based technology in your biology lab or classroom. Designed for convenience, the Biology Lab Stations contain the wireless sensors used to perform 10 Biology labs, plus many of the labs in our Essential Biology Lab Manual. The ten explorations range from the cellular to organismal level and investigate processes such as respiration, photosynthesis, enzymatic activity, membrane permeability and osmosis. Students can also investigate cell size, body regulation, and the impacts of environmental factors on reaction rates and organism responses.



Essential Biology Teacher Lab Manual

EB-6331

This printed lab manual includes 23 lab activities that can be edited to suit the needs of your students or to better coordinate with your classroom lectures. Each complete investigation includes a teacher guide and student handout. Student handouts include procedural instructions, blank graphs and tables for data entry, as well as analysis questions with space for students to record their answers. Each investigation is tightly integrated with our innovative software, sensors, and equipment.

- Enzyme Action (Pressure Sensor)
- Enzyme Action (Oxygen Sensor)
- Membrane Permeability
- Organisms and pH
- Osmosis
- Plant Respiration and Photosynthesis
- Respiration of Germinating Seeds
- Buffers in Biological Systems
- Acid Rain
- Cellular Respiration in Yeast
- Energy Content of Food
- Metabolism of Yeast
- Photosynthesis of Aquatic Plants
- Soil pH
- Transpiration
- Water and pH
- Water Purification
- Weather in a Terrarium
- EKG: Factors that Affect the Heart
- Exercise and Heart Rate
- Exercise and Blood Pressure
- Muscle Strength
- Regulation of Body Heat
- Volume of Breath

Biology Station Lab Titles

The Biology Starter Lab Station supports 7 of the 10 labs. Add the Extension Lab Station* to do all 10 lab titles.

1. Enzyme Action
2. Membrane Permeability
3. Osmosis
4. Plant Respiration & Photosynthesis*
5. Respiration of Germinating Seeds
6. Acid Rain
7. Regulation of Body Heat
8. Plant Pigments*
9. Cell Size*
10. Cellular Respiration in Yeast



The Biology Starter Lab Station

The Biology Starter Lab Station includes these wireless sensors and materials:

- ▶ Temperature
- ▶ Pressure
- ▶ pH
- ▶ CO₂
- ▶ Storage Case
- ▶ Lab Manual

**To do the remaining 3 labs listed above and another 4 labs from the Essential Biology Lab Manual, add the Extension Lab Station (see page 35) and the Essential Biology Through Inquiry Lab Manual.*

Order Information

Biology Starter Lab Station.....EB-6334

Essential Biology Teacher Lab Manual.....EB-6331

Advanced Biology Through Inquiry Labs for AP[®] & IB[®]

PASCO's award-winning Advanced Biology through Inquiry Teacher Guide is newly revised and contains 18 labs that have been specifically designed to support student inquiry, as well as AP[®] and IB[®] curriculum*. This manual is available in a print version and an all-digital version.

- ▶ Most labs can be completed in one lab session with readily available materials, including the Biology Lab Stations on the opposite page.
- ▶ Easy and meaningful data collection leads to increased time for data analysis and discussion.
- ▶ Labs integrate high-order analysis and synthesis questions.
- ▶ Includes sample data for investigations and inquiry, answers to analysis and synthesis questions, an assessment rubric, teacher tips, lab preparation information, and more.

Advanced Biology Through Inquiry Labs and Sensors Used

Lab Title

Lab Title	Starter Bundle				Extension Bundle				AP [®] Big Ideas*	IB [®] Standards**
	Temperature	CO ₂	Pressure	pH	Optical Dissolved Oxygen	Conductivity	Colorimeter	EcoChamber		
1A. Enzyme Activity			●						1, 2, 4	2.5
1B. Enzyme Activity**									1, 2, 4	2.5
1C. Enzyme Activity***									1, 2, 4	2.5
2. Diffusion				●					2	1.4, 10.3
3. Osmosis						●			2, 3	1.4
4. Plasmolysis						●			2	1.4
5. Cell Size						●			1, 2	1.1
6. Homeostasis	●								3, 4	N/A
7. Cellular Respiration		●							1, 2, 4	2.8
8. Photosynthesis					●				2, 4	2.9
9. Plant Pigments***						●			2, 4	2.9
10. Transpiration			●						2, 4	9.1
11. Mitosis	<i>No sensors required.</i>								3	1.6
12. Meiosis									3	3.3, 10.1
13. Energy Dynamics		●						●	2, 4	4.2
14. Artificial Selection	<i>No sensors required.</i>								1	N/A
15. BLAST Bioinformatics									1	3.1, B.5
16. Population Genetics									1	10.3
17. Mathematical Modeling of Evolution									1	10.3
18. Animal Behavior									2, 4	A.4

*AP is a registered trademark of the College Board, which was not involved in the production of, and does not endorse, this product. IB is a registered trademark of the International Baccalaureate Organization, which was not involved in the production of, and does not endorse, this product.

Requires Wireless O₂ Sensor; see page 28. *Requires the Wireless Spectrometer; see page 26.

Order Information

Advanced Biology Through Inquiry Teacher Guide

PS-2852A

Includes lab prep instructions, expected answers/results, and editable student files. Manual is available in eco-friendly digital format or in print.



Biology Lab Stations Support Advanced Biology

The Biology Starter and Extension Lab Stations, together with PASCO's *Advanced Biology Through Inquiry Lab Manual*, offer a truly complete Biology solution. With over 25 sensor-based labs that cover a range of Biology and Advanced Biology topics, plus all of the equipment and apparatus required to conduct the labs hands-on, inquiry with data collection and analysis has never been easier or more affordable. For investigations in Physiology, add the Physiology Bundle and extend your studies even further.



Biology Station Lab Titles

Together, the Biology Starter and Extension Lab Stations support over 20 Advanced Biology labs. Conduct the 10 labs below right out of the box.

1. Enzyme Action

2. Membrane Permeability

3. Osmosis

4. Plant Respiration & Photosynthesis*

5. Respiration of Germinating Seeds

6. Acid Rain

7. Regulation of Body Heat

8. Plant Pigments

9. Cell Size

10. Cellular Respiration in Yeast



Shown here: Biology Starter and Extension Lab Stations

The Biology Starter & Extension Lab Stations include these wireless sensors and materials:

- ▶ Temperature
- ▶ Pressure
- ▶ pH
- ▶ CO₂
- ▶ Storage Case
- ▶ Lab Manual*
- ▶ Optical Dissolved Oxygen
- ▶ Colorimeter & Turbidity
- ▶ Conductivity Sensor
- ▶ EcoChamber



Physiology Extension Bundle

PS-2935D

The Physiology Extension Bundle enables students to study the heart cycle, lung function, human respiration, stimulus and response, homeostasis, and more! This bundle includes a Wireless EKG Sensor, a Wireless Spirometer, Spirometer Mouth Pieces, a Wireless Blood Pressure Sensor with Standard Cuff, and a Wireless Hand-Grip Heart Rate Sensor.

1. Wireless EKG Sensor PS-3236
2. Hand-Grip Heart Rate PS-3206
3. Wireless Blood Pressure PS-3218
4. Wireless Spirometer PS-3234
5. Spirometer Mouth Pieces PS-2522



Order Information

Biology Starter Lab Station.....	EB-6334
Biology Extension Lab Station	EB-6335
Physiology Extension Bundle.....	PS-2935D

Biology Starter and Extension Lab Stations come standard with 10 Essential Biology Through Inquiry Labs. The Advanced Biology Through Inquiry Lab Manual is sold separately (see page 34 for order information).



Wireless Weather Sensor with GPS

PS-3209

The Wireless Weather Sensor is an all-in-one instrument for monitoring complex environmental conditions. It houses several sensing elements within a single unit to provide 19 different measurements. Use the sensor in logging mode with the Weather Vane Accessory for long-term monitoring, or use it as a handheld instrument to study microclimates and record ambient conditions relevant to environmental phenomena. You can wirelessly export data to your device for classroom analysis when group activities are constrained by time. With the built-in GPS, you can collect location data for student investigations and analyze it on the map display, powered by ESRI ArcGIS, within SPARKvue software.



Student-friendly weather dashboard to visualize its multiple sensors.

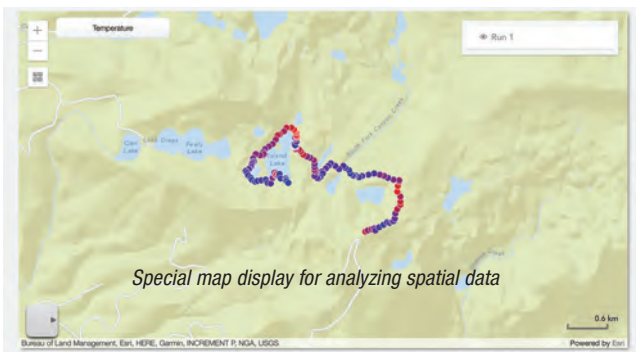

With ESRI's ArcGIS online you can visualize data in seconds with a FREE account!



Weather Vane Accessory sold separately.

Order Information

Wireless Weather Sensor with GPS	PS-3209
Weather Vane Accessory	PS-3553

Wireless Soil Moisture Sensor

PS-3228

The Wireless Soil Moisture Sensor measures the volumetric water content (%VWC) of soil, reporting data in real time or storing it onboard the sensor's memory for long-term experiments. Durable and easy to use, the Wireless Soil Moisture Sensor is the perfect tool for monitoring controlled experiments in the classroom and long-term experiments outdoors. From experiments in evaporation and soil composition to water consumption and plant competition, the Wireless Soil Moisture Sensor makes it easy for students to investigate a wide array of topics through real-time or long-term data collection.

Features:

- ▶ Collect and display data in real time within PASCO Capstone or SPARKvue software
- ▶ Automate data collection for hours, days, or weeks with remote Logging Mode
- ▶ Bluetooth connectivity enables use in the classroom, lab, or field
- ▶ Supports use of GPS data from a mobile device for GIS mapping activities
- ▶ Selectable calibrations for predominantly sandy soils, clay soils, and loamy soils



Order Information

Wireless Soil Moisture Sensor	PS-3228
-------------------------------------	---------



Wireless Temperature Sensor

PS-3201

Welcome to the modern thermometer. The Wireless Temperature Sensor transmits live data and allows students to continuously monitor, log, and plot temperature measurements on nearly any device. When lab-time ends but the experiment continues, students can set the sensor to log data autonomously for days, weeks, or months, then download it for analysis later. This durable, wireless sensor features a stainless steel probe for the most demanding of applications, as well as a battery that lasts over a year*. It can be used in a wide array of experiments and activities because it measures small, but significant temperature changes produced by chemical reactions, convection currents, and even skin temperatures.

Features:

- ▶ Simply pair and go, no cables or adapters to manage
- ▶ Variable sampling rate for capturing small, fast changes or experiments that run for hours, days, or weeks
- ▶ Bluetooth® connectivity and long-lasting coin cell battery
- ▶ Logs temperature data directly onto the sensor for long-term experiments
- ▶ Dust, dirt, and sand-proof and water resistant (IP-X7 certified)

Wireless pH Sensor

PS-3204

The Wireless pH Sensor is a must-have for any chemistry, biology, or environmental science course. Equally capable in the lab or field, the sensor eliminates the hassle of cables, reducing spills and improving safety. Plus, it rarely requires charging; the sensor's coin cell battery lasts for 2-3 years in most labs and costs about one dollar to replace. It can transmit data in real time, or store data for days when continuous monitoring is required. The Wireless pH Sensor enhances countless activities, including acid-base titrations, investigations into household chemicals, analyses of chemical reactions, water quality studies, and much more.

Features:

- ▶ Simply pair and go, no cables or interfaces to manage
- ▶ Compatible with ion-selective electrodes (ISE) and the oxidation reduction probe (ORP)
- ▶ Bluetooth® connectivity and a long-lasting coin cell battery
- ▶ Logs pH data directly onto the sensor for long-term experiments
- ▶ Wirelessly connects to SPARKvue and Capstone for convenient analysis and lab reports

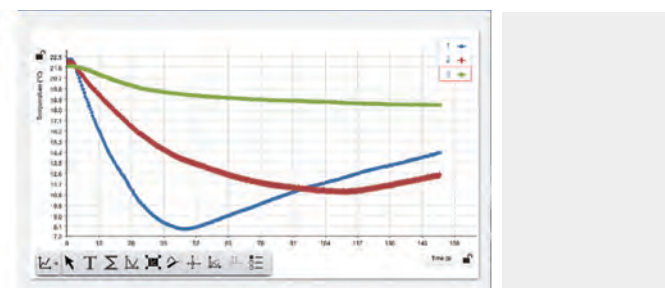

Display pH in digits, graphs, tables, or bar charts, so your students can get the most out of their measurements.

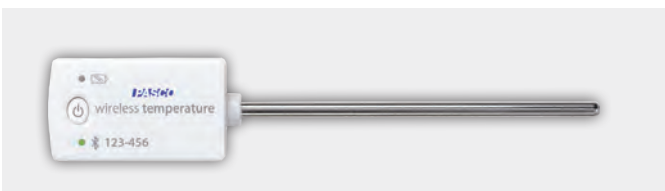

Order Information

Wireless Temperature Sensor.....PS-3201

Order Information

Wireless pH Sensor.....PS-3204



Wireless Conductivity Sensor

PS-3210

The Wireless Conductivity Sensor measures the electrical conductivity of an aqueous solution. It is ideal for investigating the properties of solutions, including total dissolved solids (TDS) for water quality inquiry. Because it is temperature compensated, calibrations are less frequent and can be applied across a range of temperatures. With a range of 0 to 20,000 $\mu\text{S}/\text{cm}$, this sensor can be utilized for chemical, biological, and environmental studies.

Teacher tip: To measure brackish or marine samples, perform a dilution until the measurement falls within the range, then multiply to determine sample conductivity.

Features:

- ▶ Measure conductivity and total dissolved solids
- ▶ Automatic temperature compensation
- ▶ Battery life >1 year
- ▶ Remote logging with built-in memory
- ▶ Dust-proof, sand-proof, and water-resistant (1 meter for 30 minutes)

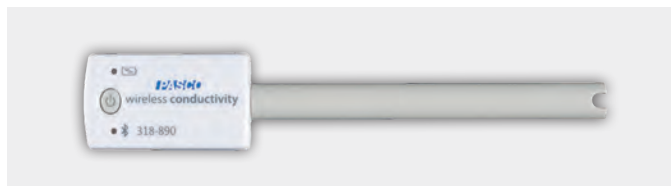

Order Information

Wireless Conductivity SensorPS-3210



Wireless Pressure Sensor

PS-3203

The Wireless Pressure Sensor allows students to easily collect accurate gas pressure data for a wide range of applications. Included is a 60cc syringe, tubing, and connectors that facilitate experiments such as Boyle's Law or measuring pinch-grip strength. Within PASCO's software, students can easily select their desired units from a list containing kPa, mmHg, inHg, mbar, psi, atm, and torr.

Features:

- ▶ Measures pressure even when the pressure within the system drops below ambient pressure
- ▶ Supports common units (kPa, atm, psi, mmHg, or N/m^2) for many applications
- ▶ Bluetooth® connectivity and long-lasting rechargeable battery

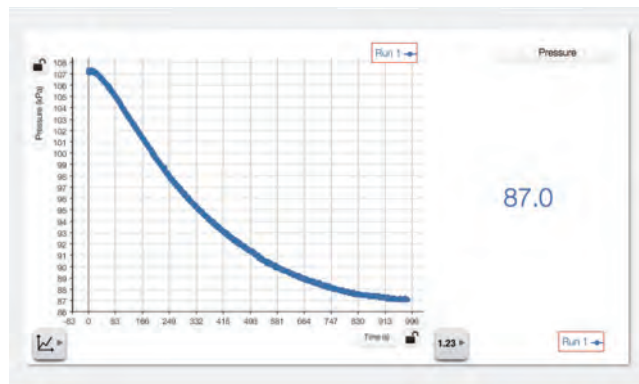

Order Information

Wireless Pressure SensorPS-3203



Wireless Light Sensor

PS-3213

The Wireless Light Sensor features two separate apertures - one for ambient light measurements and one for directional light measurements. The ambient sensor measures illuminance and UV Index, while the spot (directional) aperture measures light level and color intensity. Our software displays the relative intensities of Red, Green, and Blue light, then sums them to determine the level of White light. The light available to drive photosynthesis (PAR) and total light power per area (irradiance) are also available as calculated measurements within PASCO Capstone (version 1.8 or later) and SPARKvue software (version 2.6 or later).

Features:

- ▶ Wireless connects to computers, Chromebooks, tablets, and smartphones
- ▶ Simply pair and go, no cables or adapters to manage
- ▶ On-board memory enables the sensor to function as an independent datalogger
- ▶ Variable sampling rate for short, precise experiments or lengthy, multi-day data collection
- ▶ Bluetooth® connectivity and long-lasting coin cell battery
- ▶ Indirect PAR measurements for biological studies



Order Information

Wireless Light SensorPS-3213



Diffusion/Osmosis Kit

ME-6942

It is an image that appears in practically every biology text to help students with conceptual understanding: a U-shaped tube with a permeable membrane separating a hypotonic and hypertonic solution. And yet few classroom methods of studying osmosis take advantage of this simple and elegant design for lab work.

Features:

- ▶ Plastic rather than glass columns for durability and student safety
- ▶ Free standing unit requires no additional lab equipment to hold it in place
- ▶ Air tight joints prevent pressure leaks
- ▶ Membranes are quick and easy to replace when compromised
- ▶ Graduated transparent columns allow changes in volume to be seen and quantified
- ▶ The U-shaped design provides familiarity for students and the straight columns keep the volume of gas above the fluid constant
- ▶ Great for determining colligative effects on osmotic pressure

Wireless Temperature Sensor Link

PS-3222

The Wireless Temperature Sensor Link enables wireless connection for any PASCO temperature probe with a 3.5 mm connection. The link comes with a Fast Response Temperature Probe, but it can also connect to the Stainless Steel Temperature Probe, Skin/Surface Temperature Probe, the Absolute Zero Sphere, and the Ideal Gas Law Apparatus.



Order Information

Diffusion/Osmosis Kit.....ME-6942
 Wireless Temperature Sensor Link.....PS-3222



Wireless CO₂ Sensor

PS-3208

Measure changes in carbon dioxide (CO₂) gas levels quickly and easily with the Wireless CO₂ Sensor. The sensor is temperature compensated and can operate in high humidity environments. This sensor employs live data to make core labs, such as photosynthesis, cellular respiration, and metabolism experiments engaging and impactful. With the ability to store more than 55,000 data points, this sensor enables studies to run overnight or throughout an entire weekend for long-term carbon cycling investigations. Includes 250-ml sample bottle that enables gas sensor analysis using multiple sensors.

Features:

- ▶ Logging ability for long-term experiments, store up to 55,000 data points
- ▶ Integrated stopper for use with included sample bottle and common glassware
- ▶ Temperature compensated for increased accuracy



Wireless Oxygen Gas Sensor

PS-3217

The Wireless Oxygen Gas Sensor measures gaseous O₂ concentrations as well as humidity and air temperature for a range of biology, environmental science, and physiology activities.

The Wireless Oxygen Gas Sensor is accurate and easy to use, making it the perfect sensor for studying photosynthesis, respiration, and oxygen cycling in a closed or open system. With remote logging, experiments can go beyond the lab period and easily give students hours or days of data for analysis. In addition to measuring oxygen gas levels, the Wireless Oxygen Gas Sensor also contains sensors to measure ambient temperature and humidity.

Features:

- ▶ Bluetooth® and USB connectivity
- ▶ 0-100% Oxygen Gas Concentration
- ▶ ±1% Oxygen at constant temperature and pressure
- ▶ Also reports ambient temperature and humidity
- ▶ 2-3 year operating life with replaceable sensing element

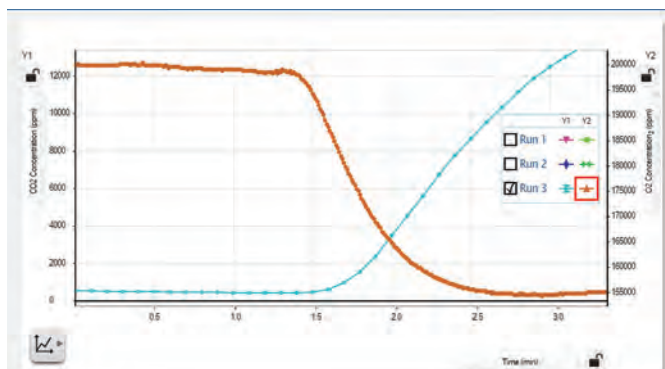

Metabolism Chamber

ME-6936

The Metabolism Chamber is a 250 mL sample bottle with 2 holes cut specifically for PASCO gas sensors to allow simultaneous measurements of carbon dioxide gas and oxygen gas.



Order Information	
Wireless CO ₂ Sensor.....	PS-3208

Order Information	
Wireless Oxygen Gas Sensor.....	PS-3217
Metabolism Chamber.....	ME-6936



Wireless Optical Dissolved Oxygen Sensor

PS-3224

The Wireless Optical Dissolved Oxygen (ODO) Sensor is ideal for monitoring DO₂ in the lab or field. The Wireless Optical DO Sensor contains three different probes. In addition to the dissolved oxygen sensor, it also includes probes for measuring atmospheric pressure and water temperature. The optical technology is accurate, fast, and does not require stirring, filling solutions, warm-up, or frequent calibration. When equipped with the included cover, the sensor has a waterproof design and is submersible to a depth of 10 m.

A PASCO exclusive feature allows you to log data using the sensor's built-in memory. After collecting data for hours or even days, simply connect the sensor to your device and you're ready to download your data. With this powerful sensor, educators can explore day and night nutrient cycles, changes in metabolic processes, seasonal changes in water quality, and more.

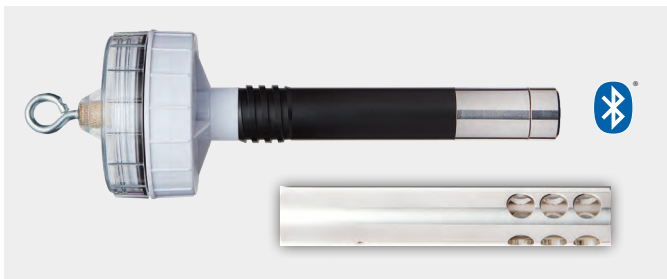

Wireless Optical Dissolved Oxygen Sensor Metal Guard

PS-3604

This metal guard protects the sensing element of the Wireless Dissolved Oxygen Sensor. It also helps weigh the sensor down when making measurements under water.

Order Information

- Wireless Optical Dissolved Oxygen SensorPS-3224
- Wireless Optical Dissolved Oxygen Sensor Metal Guard PS-3604



Photosynthesis Tank

PS-2521B

Typical experiments involving photosynthesis require students to infer photosynthetic rate changes by using chloroplasts and dye. Help your students understand this concept more completely with the Photosynthesis Tank, which allows you to directly measure the production of oxygen. The tank's lid features a convenient slot for sensors. We recommend using a pH, Wireless CO₂ Sensor, and/or a Wireless Optical Dissolved Oxygen Sensor.

Features:

- ▶ Outer tank can act as water bath to control temperature
- ▶ Can be placed on a hot plate to study the effects of temperature
- ▶ Dyes can be used to add color filters between the tanks



Order Information

- Photosynthesis TankPS-2521B

Greenhouse Sense & Control Kit

NEW

ST-2997

Designed for the exploration of biological and ecological concepts, the Coding with Greenhouse Sensor Technologies Kit includes everything students need to design, build, program, and study their very own greenhouse.



This complete kit includes: an EcoChamber and //control.Node; a breakout board; a fan; a water pump; tubing with drip-watering ends; a red and blue light; and a Greenhouse Sensor that measures light, temperature, humidity, and soil moisture.

Order Information

- Greenhouse Sense & Control Kit.....ST-2997



EcoZone System

ME-6668

PASCO's EcoZone System is designed to help students model and understand complex interactions within, and among, different ecosystems. The three clear, acrylic EcoChambers are specially designed to accommodate PASCO sensors, making qualitative and quantitative measurements easily accessible.

With three interconnected chambers, students can model interactions between three different ecosystems. Choose the traditional terrestrial, aquatic, and decomposition environments, or create unique biomes to model and measure. With the EcoZone System, students can create two identical ecosystems for precise control of variable impact, decouple the system for isolated investigations, or connect all three chambers to study interactions.

Features:

- ▶ Total volume of each chamber is 4534 cubic centimeters
- ▶ Sturdy construction designed for easy setup and cleanup
- ▶ Quantitatively study the interaction of different ecosystems
- ▶ Custom molded for use with PASCO sensors
- ▶ Clear acrylic allows for observations from all sides

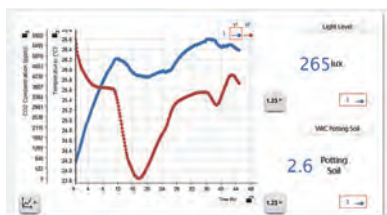

Order Information

EcoZone SystemME-6668
EcoChamberME-6667



Wireless Colorimeter & Turbidity Sensor

PS-3215

The Wireless Colorimeter & Turbidity Sensor simultaneously measures the absorbance and transmittance of six different wavelengths. The sensor can be used to study Beer's Law (absorbance vs. concentration), enzyme activity, photosynthesis, and the rates of chemical reactions (absorbance vs. time). After a simple calibration, students can quickly begin viewing live measurements as they materialize across the visible spectrum at 650 nm (red), 600 nm (orange), 570 nm (yellow), 550 nm (green), 500 nm (blue), and 450 nm (violet).

This sensor also functions as a high-quality turbidimeter for water quality analysis. Rather than simply measuring transmitted light, the Wireless Colorimeter and Turbidity Sensor measures light scattered at a 90 degree angle from the sample, resulting in accurate and repeatable measurements. Calibration curves for the EZ-Snap water quality concentrations can now be reported in parts per million (PPM) directly from software.

Features:

- ▶ Stabilized light source for consistent readings
- ▶ PASCO software displays the absorbance & transmittance at each wavelength in the appropriate color
- ▶ Quick and easy calibration
- ▶ Functions as both a colorimeter and turbidimeter
- ▶ Built-in calibrations report concentrations of Ammonium, Nitrate, Phosphate, and Iron in parts per million using EZ Snap Kits.



Measure the absorbance and transmittance of a solution at six different wavelengths... simultaneously!



Order Information

Wireless Colorimeter & Turbidity SensorPS-3215
Includes USB Charging cable, 9 cuvettes, 2 cuvette racks, and one 100 NTU calibration cuvette.



Wireless Spectrometer (VIS)

PS-2600

PASCO's Wireless Spectrometer is specifically designed for modern chemistry, biology, and physics labs. With both Bluetooth and USB connectivity, students can quickly connect from their device or computer using the free PASCO Spectrometry Software. Scans are fast, enabling students to collect a full spectrum of data in under one second. After specifying a target wavelength, students can study concentrations (Beer's Law), rates of reactions (Kinetics), or investigate emission spectra using the optional fiber optic cable. Includes fluorescent excitation at 405 and 500 nm.

Perform these labs with the PASCO Spectrometer:

- ▶ Photosynthesis with DPIP
- ▶ Absorption spectra of plant pigments
- ▶ Concentration of proteins in solution
- ▶ Rate of an enzyme-catalyzed reaction
- ▶ Growth of a cell culture



Includes USB charging cable, 10 cuvettes, and Spectrometry Software.



Order Information

Wireless Spectrometer (VIS).....PS-2600



UV-Vis Spectrometer NEW

SE-3607

The SE-3607 is an easy-to-use, wide range UV-Vis spectrometer that delivers fast, accurate and reliable performance for routine analyses in chemistry and biochemistry teaching labs. With USB connectivity and cross-platform Spectrometry Software, the PASCO UV-Vis Spectrometer improves collaboration between lab members, enabling data collected on a computer or laptop to be analyzed on tablets, iPads, and Chromebooks*. Additional accessories, such as the Quartz Fiber Optic Cable Set, can be used to extend the spectrometer's capabilities for the analysis of emission spectra, light sources, and the classification of lasers.

Highlights:

- ▶ Uses Pasco's award winning Spectrometry software
- ▶ Spectrometry app is freely downloadable
- ▶ Easy to calibrate (dark - shutter closed & light - cuvette with solvent)
- ▶ Easy to rename runs (click and edit)
- ▶ Allows scan averaging, signal integration time, and smoothing
- ▶ Graphs entire spectra with each scan
- ▶ Graphs chosen wavelength change over concentration (Beer's Law)
- ▶ Graphs change in absorption over time (Kinetics)
- ▶ Allows bandwidth averaging and variable sample rate time graphs

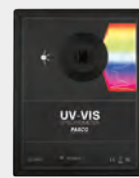

Semi-Microvolume Cuvettes (Qty. 10), Cuvette Rack: EC-3590, USB-A to USB-B Cable, External AC Adapter, 24 V Power Supply, Foam Lined Carrying Case (ABS).

UV Quartz Cuvettes (Qty. 2)



Sold Separately

UV-Vis Fiber Optic Cable Set



Sold Separately

Order Information

UV-Vis Spectrometer.....SE-3607
 UV Quartz Cuvettes (Qty. 2).....SE-3611
 UV-Vis Fiber Optic Kit.....SE-7182



Wireless Hand-Grip Heart Rate Sensor

PS-3206

With these wireless hand grips, conducting physiology labs on the cardiovascular system or homeostasis is easier than ever before. Continuously monitor heart rate during exercise, or use the sensor to take initial and final measurements with fast and reliable heart rate detection.



Order Information

Wireless Hand-Grip Heart Rate SensorPS-3206

Wireless Exercise Heart Rate Sensor

PS-3207

The Wireless Exercise Heart Rate Sensor has a chest strap and will transmit data wirelessly up to 10 m away! The electrode belt fits around the ribcage (worn against the skin for best results, but can be worn over a shirt if a drop of saline solution is applied under the electrodes). Live and recorded data can be analyzed using any device with PASCO software installed.



Order Information

Wireless Exercise Heart Rate SensorPS-3207



Wireless Blood Pressure Sensor with Standard Cuff

PS-3218

PASCO's Wireless Blood Pressure Sensor allows students to quickly and easily measure both systolic and diastolic arterial blood pressure (mmHg) as well as heart rate (pulse in bpm). Comparing the digits display for systolic and diastolic pressure with the display of blood pressure from the real-time graph helps students gain a contextual understanding of the physiology of blood pressure.



Observe heart rate plus systolic and diastolic blood pressure



Order Information

Wireless Blood Pressure Sensor with Standard Cuff.....PS-3218



Wireless Spirometer **NEW**

PS-3234

The Wireless Spirometer Sensor makes it safe and easy for students to collect respiratory measurements, including flow rate, pressure, and lung volume. Ideal for studies in health and human physiology, the Wireless Spirometer Sensor streamlines experiments by providing students with real-time data, interactive graphs, and intuitive analysis tools right on their devices. The disposable mouthpieces are designed for use with a single student and feature exchangeable filters that protect the sensor from particulates for maximum safety. Additional mouthpieces are available in convenient packs of ten.

Features:

- ▶ Bi-directional air flow (inspiration and expiration)
- ▶ Minimal resistance to air flow
- ▶ Displays volume in liters
- ▶ Exchangeable filter and disposable, hygienic mouthpieces

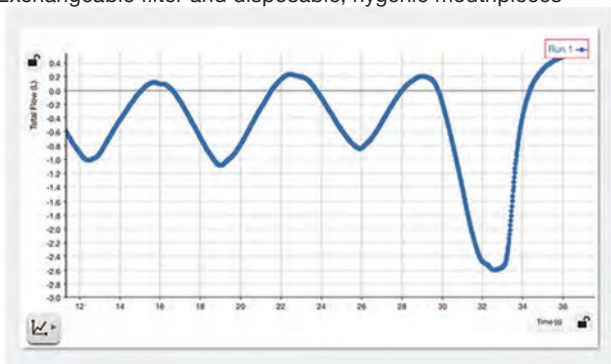

Order Information

Wireless Spirometer.....	PS-3234
Spirometer Mouth Piece Replacements (10).....	PS-2522
Spirometer Mouth Piece Prefilter (10)	PS-3245

Wireless EKG Sensor **NEW**

PS-3236

The Wireless EKG Sensor measures electrical signals produced by contractions of the heart or muscles, and reports them in real-time on virtually any student device. The perfect sensor for fast-paced physiology courses, the EKG Sensor provides students with real-time feedback as they explore the effects of various stimuli on cardiac or muscular activity. Heart Rate data is reported in beats per minute (BPM), while the voltage (mV) detected from cardiac contractions is intuitively displayed in an EKG trace.

Features:

- ▶ Standard three-electrode design
- ▶ Easy-to-use, disposable stick-on electrodes
- ▶ No messy gel required
- ▶ Great for stimulus response reflex studies

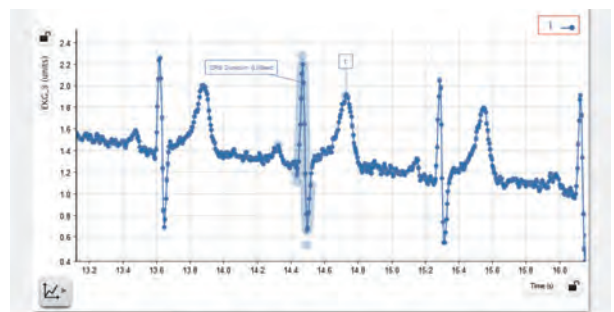

Order Information

Wireless EKG Sensor.....	PS-3236
--------------------------	---------



Go Wireless with PASPORT Sensors

PASCO's AirLink Interface connects PASPORT (blue or black) sensors to your computer using Bluetooth or USB technology.



AirLink Interface

PS-3200

The Airlink connects PASPORT sensors to a Mac or Windows computer, Chromebook, iPad, tablet, or smartphone via Bluetooth or USB connection. The USB cable is included.



Order Information

AirLink InterfacePS-3200



Human Arm Model

PS-2611

The Human Arm Model simulates the muscles and motion of an actual human arm. To activate the arm motion, students pull on the cord with a Force Sensor. Changes in position are measured at the shoulder and elbow using the two built-in potentiometers plugged into the included Angle Sensor (PS-2139). From this information, the torque applied when lifting an object can be determined. Also, students can evaluate the work done by the arm in throwing a ball and the resulting kinetic energy delivered to the ball.

The Arm can perform many types of motion, such as extending and lifting an object, curling, or throwing a ball overhand. Different arm muscles are activated depending on which pulleys are selected. Static force measurements can also be made to see how the muscle tension changes at various arm positions.

Applications:

- ▶ Evaluate the work done when throwing a ball
- ▶ Measure the torque produced from lifting weights
- ▶ Associate Triceps/Biceps muscle action with arm motion
- ▶ Investigate different levels of muscle tension

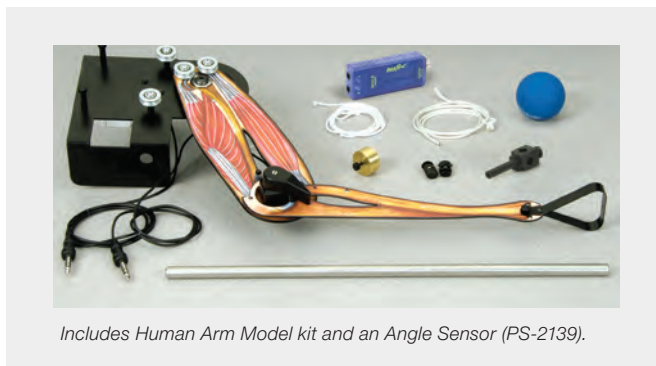

Includes Human Arm Model kit and an Angle Sensor (PS-2139).

Order Information

Human Arm ModelPS-2611



Human Eye Model

0S-8477A

The Human Eye Model makes it easy for students to explore the physiology behind human sight through hands-on manipulation. Investigate normal vision, far-sightedness, and more!

Features:

- ▶ **Working Model of the Human Eye:** Two lenses are used to form images on the retina. Sealed tank holds water to simulate the vitreous humor. Size and orientation of the illuminated object can be easily measured.
- ▶ **Study the Optics of Normal Vision and Vision Correction:** Use the included plastic lenses to create images for normal vision, far-sightedness, near-sightedness, and astigmatism. Additional lenses are placed in front of the eye to correct for vision problems.
- ▶ **Fixed Corneal Lens and Interchangeable Crystalline Lens:** The crystalline lens is surrounded by water (vitreous humor). By changing the crystalline lens, the eye can focus on both near and far objects.
- ▶ **Movable Retina:** Three positions demonstrate near-sightedness, far-sightedness, and normal vision.
- ▶ **Variable Pupil Size:** Students can observe the change in brightness and clarity of the image as the pupil size is reduced.



Includes molded plastic eyeball, plastic lenses (two sets of 6), pupil aperture, adjustable focal lens, retina screen, optics caliper (1), syringe, and experiment manual.

Order Information

Human Eye Model.....0S-8477A

Microscope with Detachable Tablet (40-1000x)

SE-6203

The SE-6203 features the same high speed, full-resolution imaging technology built into some of our most popular microscopes. The 8" WiFi digital tablet transmits live images to iOS and Android devices. Use it as a conventional microscope, or share live images using a WiFi tablet, wireless laptop, or HD-ready LCD monitor/projector through HDMI. Tablet includes preloaded Motic apps. Connect, view, and share images easily and affordably with the SE-6203.



Order Information

Microscope with Detachable Tablet (40-1000X) ...SE-6203

USB 3.0 Microscope Camera

SE-6204

This high-resolution camera permits you to use your own microscope to create still or moving microscope images on your PC. With the included Motic Images Plus software, you can view, enhance, label, measure, print, and store the images all with one program. This lightweight digital camera mounts over almost any microscope eyepiece (stereo or compound) with the supplied C-ring adapter and microscope eyepiece adapters. Provides 3.0 megapixels at 2048x1536 framed resolution, everything included for easy plug-and-play, for use with Windows 7 and above and OSX.



Moticam X3 (SE-6205) streaming high resolution WiFi camera also available. See the PASCO website for more details.

Order Information

USB 3.0 Microscope CameraSE-6204
WiFi Microscope CameraSE-6205

USB Camera Microscope

PS-2343

The versatile USB Camera Microscope is ideal for a variety of applications in the science classroom. Its dual functionality means it can take pictures just like a digital camera, but it can also magnify like a microscope when it's up close to a specimen.

Features:

- ▶ Built-in LED lights
- ▶ Optical zoom from 1x to 60x
- ▶ Can be used as a webcam



Order Information

USB Camera MicroscopePS-2343



Award-Winning Solutions for Your Chemistry Lab

PASCO provides chemistry educators with the most complete and innovative classroom solutions on the market. Our goal is to provide teachers with affordable, turnkey STEM solutions that combine versatile sensor technology with interactive, NGSS-based curriculum. Using SPARKvue® software and our wireless sensors, students can see data collection in real time and perform analyses on their own devices. Plus, our *Essential Chemistry* textbook and interactive e-book make it easy to reinforce student engagement at home and in the classroom.

Chemistry Index

Chemistry Lab Stations	49, 53
Essential Chemistry Curriculum	50-51
Advanced Chemistry Solutions	52-53
pH & Wireless Drop Counter	54-55
Temperature & Heat Stirrer	56
Ideal Gas Law & Absolute Zero Sphere	57
Pressure & Conductivity	58
Electrochemistry with Voltage & Current	59
Molecular Model and Geiger Counter	60
Polarimeter, Polarizer Demonstrator	61
Wireless Colorimeter & Turbidity	62
Wireless Spectrometer	63
Spectrometer Buying Guide and UV-Vis Spectrometer ...	64-65

World Class Support & Professional Development *Committed to Your Success*

We want you to have all the support, guidance, and training you need. Just let us know how we can help.

CONTACT US TODAY

pasco.com

or +1 916-786-3800



Chemistry Starter Lab Station

EC-6362

The Chemistry Starter Lab Station makes it easy and affordable to begin using sensor-based technology in your chemistry lab or classroom. Inside the Starter Lab Station are the wireless sensors used to perform lab activities from the Essential Chemistry Student Lab Manual. Available separately is the Chemistry Extension Lab Station (EC-6363) which, when combined with the Starter Lab Station, comprises all the wireless sensors students need to perform most of the labs inside the Essential Chemistry Student Lab Manual, plus many of the lab activities found in our Advanced Chemistry Through Inquiry Teacher Guide.

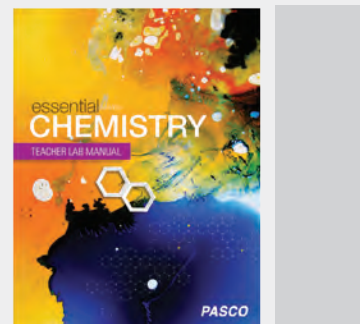

Essential Chemistry Teacher Lab Manual

EC-6330

The Essential Chemistry Teacher Lab Manual is a complete set of teacher answer keys for the 73 labs inside the Essential Chemistry Student Lab Manual (the printed student lab manual is sold separately). Each teacher key provides sample data, graphs, tables, and correct or sample responses to the analysis questions within each of the 73 student lab investigations. Below is a partial list of labs from the Essential Chemistry Lab Manual:

- Experimental Variables
- Density of a Liquid
- Physical or Chemical Change
- Specific Heat
- Naming Ionic Compounds
- Molar Mass
- Percent Composition of a Hydrate
- Empirical Formula of Magnesium Oxide
- Chemical Reactions
- Solubility Rules
- Determining Limiting Reactants
- Flame Tests
- Lewis Structures and VSEPR
- Evaporative Cooling
- Hess's Law
- Boyle's Law
- Charles' Law
- Solution Concentration
- Catalysts
- Le Châtelier's Principle
- Titration of an Unknown Acid
- Electrochemical Cells
- Electroplating
- Bonding and Organic Chemistry
- + 49 more labs available.

Chemistry Station Lab Titles

The Chemistry Starter Lab Station supports 7 of the 10 included labs. Add the Extension Lab Station* to do all 10 lab titles + over 50 more investigations from the Essential Chemistry Lab Manual.

1. Physical or Chemical Change

2. Specific Heat

3. Chemical Reactions

4. Determining Limiting Reactions

5. Types of Bonding*

6. Evaporative Cooling

7. Solution Concentration*

8. What is pH

9. Investigation of Acid-Base Titration

10. Lemon Battery*

The Chemistry Starter & Extension Lab Stations include these wireless sensors and materials:

Starter

- ▶ Temperature
- ▶ Pressure
- ▶ pH
- ▶ Molecular Model
- ▶ Periodic Table
- ▶ Periodic Trend Cards
- ▶ Spectrum Cards
- ▶ Storage Case

Extension

- ▶ Drop Counter
- ▶ Colorimeter & Turbidity
- ▶ Conductivity
- ▶ Voltage
- ▶ Condenser
- ▶ Electrode Support



Shown here: Chemistry Starter & Extension Lab Stations

Order Information

Chemistry Starter Lab StationEC-6362
 Chemistry Extension Lab Station.....EC-6363
 Essential Chemistry Teacher Lab ManualEC-6330

Your COMPLETE Chemistry Solution



PASCO's Essential Chemistry curriculum is the only curriculum solution that includes a Student Textbook, Student e-Book, Teacher e-Resources, Student Lab Manual, Teacher Lab e-Resources, and Equipment Kits, all at a very affordable price. This 3-D STEM program includes a full year of instruction for both General and

Honors Chemistry classes. Use our complete solution or integrate Essential Chemistry into your existing curriculum. Essential Chemistry is multiplatform and works on iOS, Android™, Chrome™, Windows®, and Mac®. What's more, it includes 24/7 online access, as well as correlations to NGSS and your state standards.

Student Textbook & Lab Manual

- ▶ 24 chapters cover a full year of instruction for General and Honors Chemistry
- ▶ One main idea per page
- ▶ Quality illustrations
- ▶ Section and Chapter Reviews
- ▶ 73 complete investigations
- ▶ 4 Design Projects

Student e-Book

- ▶ Browser-based version of the textbook
- ▶ Same layout with convenient 24/7 online access
- ▶ Embedded videos and animations bring content to life
- ▶ Interactive equations and simulations enrich key concepts
- ▶ Formative and summative assessment questions

Teacher e-Resources for Lab Manual

- ▶ Editable documents
- ▶ SPARKvue Software
- ▶ PowerPoint presentations
- ▶ Answer keys
- ▶ Video lab assistance

Teacher e-Resources for Textbook

- ▶ Infinite Test Bank
- ▶ Teacher User Guide
- ▶ Teacher e-Book (1-year or multi-year license)
- ▶ Alignment details for NGSS and state standards

PASCO Academy Chemistry Resources

- ▶ Available through your PASCO Educator account
- ▶ 25 engaging video labs with detailed instruction and data collection
- ▶ 25 datasets for student analysis and discussion
- ▶ 25 editable lab handouts with teacher answer keys
- ▶ Digital access to more than 70 labs for General and Honors Chemistry

Equipment

- ▶ Standard Equipment Kit supports 47 labs
- ▶ Extend your investigations with additional sensors and apparatus

Essential Chemistry correlates with NGSS and is constructed around the three dimensions:

- ▶ Science and Engineering Practices
- ▶ Crosscutting Concepts
- ▶ Disciplinary Core Ideas



Textbook + e-Book + Equipment

Essential Chemistry Student Textbook

EC-6350

This rigorous yet accessible textbook includes core Chemistry topics that cover a complete year of instruction. The lessons follow the 5E model and include tools for ELL students, as well as tools for students with different learning styles. And the curriculum aligns to your standards for both regular and advanced coursework. The accessible textbook includes one main idea per page, quality illustrations, 73 complete investigations, four Engineering Design Projects, and Section and Chapter Reviews. The 24 chapters cover these topics:

- ▶ The Science of Chemistry
- ▶ Measurement and Analysis
- ▶ Classifying Matter
- ▶ Temperature and Heat
- ▶ Chemical Compounds
- ▶ Moles
- ▶ Chemical Reactions
- ▶ Stoichiometry
- ▶ Atomic Structure
- ▶ Bonding and Valence
- ▶ Energy and Change
- ▶ Gases
- ▶ Solutions
- ▶ Reaction Rates
- ▶ Equilibrium
- ▶ Acids and Bases
- ▶ Oxidation and Reduction
- ▶ Electrochemistry
- ▶ Nuclear Chemistry
- ▶ Organic Chemistry
- ▶ Molecular Biology
- ▶ Biochemistry
- ▶ The Earth
- ▶ The Universe

Essential Chemistry Student e-Book

EC-6350-EB5 (5-yr lic) or EC-6350-EB1 (1-yr lic)

The e-Book is an electronic version of the full textbook plus interactive elements. Throughout the electronic text, content and theory are supported with optional audio reading, as well as interactive elements such as interactive equations, videos, animations, and simulations. Students may also expand content using the 'more' button to go deeper into concepts.

Essential Chemistry Student Lab Manual

EC-6352

The *Essential Chemistry* Student Lab Manual is a student-consumable print book. In the manual there are 73 labs that cover a full year of instruction. Best of all, the labs are completely integrated with PASCO equipment and software.

Essential Chemistry Standard Equipment Kit*

EC-6361

This equipment kit will outfit a single chemistry lab station of 2-5 students. When used in conjunction with the *Essential Chemistry* program, including the e-Book and lab manual, it creates a complete solution for teaching high school chemistry. It can also be used to supplement your existing textbook, serving as the lab component of your curriculum. This use is supported by the more than 70 standards-based *Essential Chemistry* labs that are available for free download in the PASCO Experiment Library.



**AWARD
WINNING
EQUIPMENT**

Standard Equipment Kit

42 labs are designed to use this equipment set.

Includes 1 of each of the following:

- Wireless Temperature Sensor, PS-3201
- Wireless pH Sensor, PS-3204
- Wireless Conductivity Sensor, PS-3210
- Wireless Pressure Sensor, PS-3203
- Wireless Voltage Sensor, PS-3211
- Wireless Colorimeter and Turbidity, PS-3215*
- Molecular Model Kit, PS-3400
- Electrode Support, PS-3505
- Gratnells® Storage Trays (2)
- Periodic Trend Cards, EC-3405
- Periodic Table, EC-3404
- Spectrum Cards, EC-3403
- Condenser, PS-3402

*This equipment kit contains everything in the *Chemistry Starter and Extension Lab Station kits* (EC-6362 + EC-6363) except the *Wireless Drop Counter* (PS-3214).

Order Information

Essential Chemistry 1st Edition: Student Textbook.....EC-6350A
Essential Chemistry 1st Edition: Student e-Book (1 year lic)....EC-6350-EB1
Essential Chemistry Student Lab Manual.....EC-6352

Essential Chemistry Teacher Lab ManualEC-6330
Essential Chemistry Lab Investigations - Teacher Res.) EC-6353-DIG
Essential Chemistry Standard Equipment Kit.....EC-6361

Advanced Chemistry Through Inquiry Labs for AP[®] & IB[®]

PASCO's Advanced Chemistry through Inquiry Teacher Guide is newly revised and contains 16 labs that have been specifically designed to support student inquiry, as well as AP[®] and IB[®] curriculum*. This manual is available in both a print version and an all-digital version.

- ▶ Most labs can be completed in one lab session with readily available materials, including the sensor bundles on the opposite page.
- ▶ The flexible format provides guided inquiry opportunities and scaffolding, so students can create their own experiments.
- ▶ Easy and meaningful data collection leads to increased time for data analysis and open inquiry.
- ▶ Labs integrate high-order analysis and synthesis questions.
- ▶ Includes sample data for investigations and inquiry, answers to analysis and synthesis questions, an assessment rubric, teacher tips, lab preparation information, and more.

Initial Investigation includes step-by-step procedure, questions, and analysis.

Advanced Investigation presents a higher level experiment that expands on concepts from the Initial Investigation.

Extended Inquiry includes student inquiry and experimental design questions with sample answers.

Advanced Chemistry Through Inquiry Labs and Sensors Used

Lab Title

Lab Title	Starter Bundle				Extension Bundle			AP [®] Big Ideas*	IB [®] Standards**
	Temperature	Pressure	pH	Conductivity	Colorimeter	ORP Probe	Drop Counter		
1. Analyzing Food Dyes in Sports Drinks					●			1.3, 11.2, 11.3	1.15, 1.16
2. Investigating the Copper Content of Brass**					●			1.2, 11.2, 11.3, 12.1	1.16, 3.4
3. How Hard Is Your Tap Water?			●	●				1.2, 1.3	1.19, 2.10, 3.2, 3.3
4. How Much Acid is in Your Fruit Juice?			●				●	1.3, 8.1-8.4, 18.2, 18.3	1.20, 3.3
5. Separating Food Dyes Using Chromatography**					●			1.1, 4.4	1.20, 2.3
6. A Chemistry Mystery: Name That Unknown!				●				1.1, 4.1, 4.4	2.22, 2.24, 2.32
7. Stoichiometry in Solutions	●			●			●	1.2, 1.3	1.5, 3.3
8. Percentage of H ₂ O ₂ in Your Drugstore Hydrogen Peroxide							●	9.1	3.9, 1.20, 3.3
9. Investigating the Physical and Chemical Changes of Matter	●	●	●	●				1.1, 4.1, 4.4	2.3, 2.5, 3.1, 3.10, 5.10
10. What Does Acid Rain Do to Coral Reefs?		●						6.1	4.1, 4.2
11. Kinetics of Crystal Violet Fading					●			16.1	4.2, 4.1
12. Building a Better Hand Warmer	●							5.1, 5.3	5.6, 5.7
13. Applications of Le Chatelier's Principle**	●				●			7.1, 17.1	6.9, 6.10
14. Investigation of Acid-Base Titrations			●				●	1.3, 8.1-8.4, 18.2, 18.3	1.20, 6.11, 6.12, 6.13
15. Introduction to Buffers			●				●	18.3	6.20, 1.20
16. Evaluating Lemonade as a Buffer			●				●	18.3	6.18, 1.4

*AP is a registered trademark of the College Board, which was not involved in the production of, and does not endorse, this product. IB is a registered trademark of the International Baccalaureate Organization, which was not involved in the production of, and does not endorse, this product.

**Requires the Wireless Spectrometer; see page 53.

Order Information

Advanced Chemistry Through Inquiry.....PS-2828A

Includes lab prep instructions, expected answers/results, and editable student files. Manual is available in eco-friendly digital format or in print.

Lab Stations Support Advanced Chemistry

The Chemistry Starter Lab Station and Extension Station, together with PASCO's *Advanced Chemistry Through Inquiry Lab Manual*, offer a truly complete solution. With over 15 sensor-based labs covering a range of Advanced Chemistry topics, and all of the equipment and apparatus required to conduct the labs, hands-on inquiry with data collection and analysis has never been easier or more affordable. Add the Wireless Spectrometer and Oxidation Reduction Potential Probe to the Lab Stations, for more IB® and AP® investigations.



Wireless Spectrometer (VIS)

PS-2600

The Wireless Spectrometer from PASCO is specifically designed for modern chemistry, biology, and physics labs. With Bluetooth and USB connectivity, students can quickly connect from their device or computer using the free PASCO Spectrometry Software. Scan times are fast, allowing students to gather a full spectrum of data in under one second. After specifying a target wavelength, students can study concentrations (Beer's Law), reaction rates, or investigate emission spectra using the optional fiber optic cable.



Oxidation Reduction Potential Probe

PS-3515

This probe connects to the Wireless pH Sensor and allows students to determine the ability of a species in a solution to act as an oxidizing agent or reducing agent during redox reactions.

Use this probe to monitor solutions during oxidation-reduction titrations, perform water quality studies, and study the effects of water chlorination. This probe is not a standalone sensor. It connects to and requires an amplifier.



The Chemistry Starter & Extension Lab Stations include these wireless sensors and materials:

Starter

- ▶ Temperature
- ▶ Pressure
- ▶ pH
- ▶ Molecular Model Kit
- ▶ Periodic Table
- ▶ Periodic Trend cards
- ▶ Spectrum Cards
- ▶ Storage Case

Extension

- ▶ Drop Counter
- ▶ Colorimeter & Turbidity
- ▶ Conductivity
- ▶ Voltage
- ▶ Condensor
- ▶ Electrode Support



Order Information

Chemistry Starter Lab StationEC-6362
 Chemistry Extension Lab Station.....EC-6363

Wireless Spectrometer (VIS).....PS-2600
 Oxidation Reduction Potential Probe.....PS-3515



Wireless pH Sensor

PS-3204

The Wireless pH Sensor is a must-have for any chemistry, biology, or environmental science course. Equally capable in the lab or field, the sensor eliminates the hassle of cables, reducing spills and improving safety. Plus, it rarely requires charging; the sensor's coin cell battery lasts for 2-3 years in most labs and costs about one dollar to replace. It can transmit data in real time, or store data for days when continuous monitoring is required. The Wireless pH Sensor enhances countless activities, including acid-base titrations, investigations into household chemicals, analyses of chemical reactions, water quality studies, and much more.

Features:

- ▶ Simply pair and go, no cables or interfaces to manage
- ▶ Compatible with ion-selective electrodes (ISE) and the oxidation reduction probe (ORP)
- ▶ Features Bluetooth® wireless connectivity and a long-lasting coin cell battery
- ▶ Logs pH data directly onto the sensor for long-term experiments
- ▶ Wireless connection to SPARKvue and Capstone for intuitive analysis and lab reports



Collect measurements, compare pH levels of various solutions, and display data as a graph, digits display, table, and/or histogram.



Order Information

Wireless pH Sensor.....PS-3204

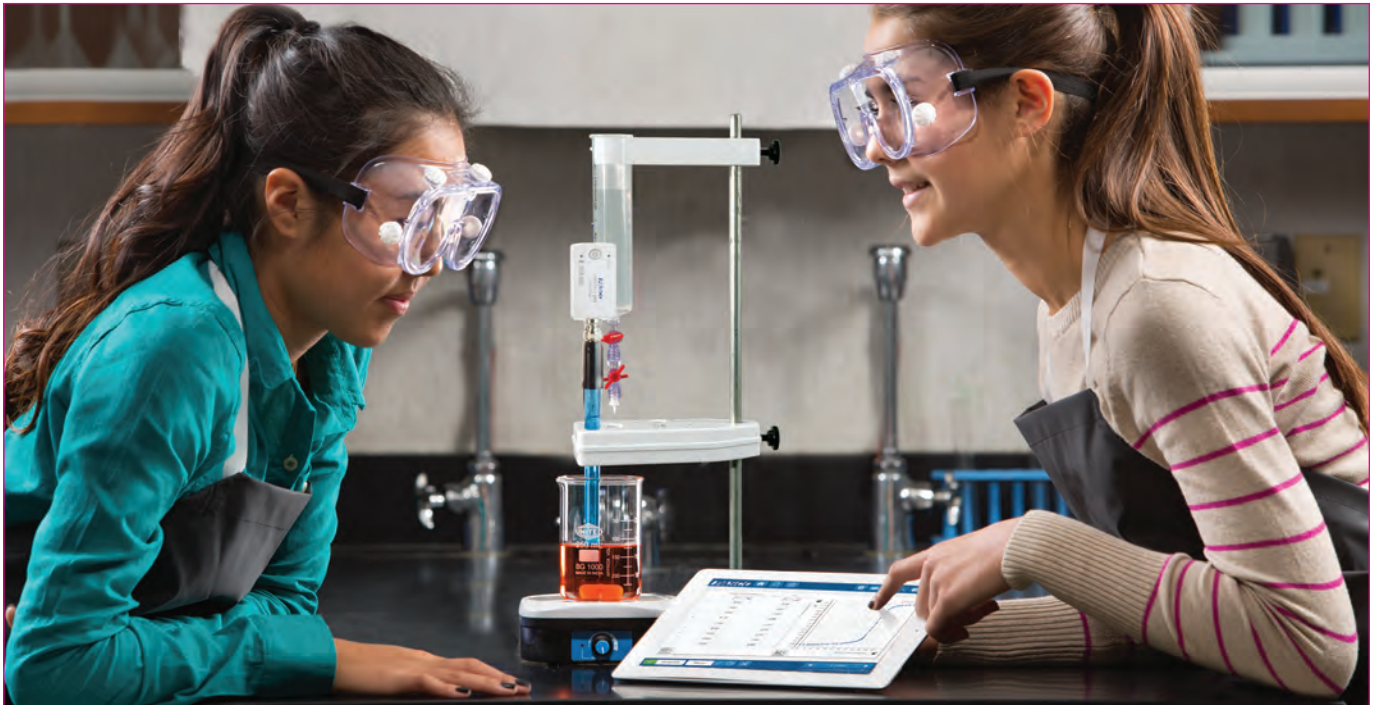

Wireless Drop Counter

PS-3214

The Wireless Drop Counter has a wide (18 x 13 mm) drop window for better drop detection and easier alignment with burettes. It works equally well with large or small, fast or slow drops.

Measures up to 40 drops per second with drops as small as 0.5 mm.

Teaching Advantage:

- ▶ IR filter assures accurate counts because room lighting cannot affect results
- ▶ Sensor unit can suspend two other probes in solution, simplifying many experiments
- ▶ Wide drop window (18x13mm) means better drop detection and easier alignment with burettes

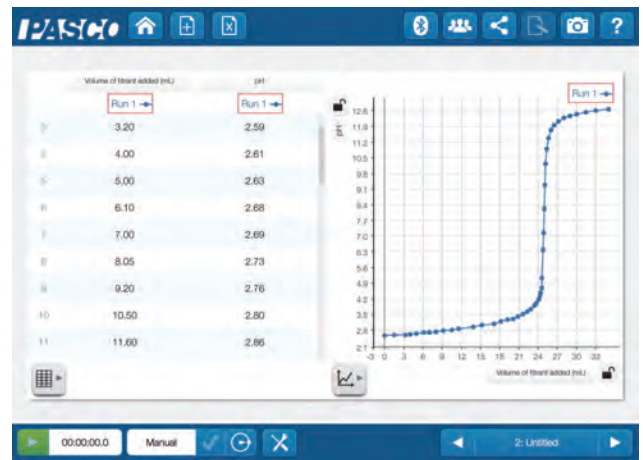

Includes: Wireless Drop Counter, Stopcock Valves (2), 60 cc Drop Dispenser Syringe with Tip, and Syringe Holder. Included but not shown: Micro Stir Bar and Micro USB Cable (1 m.)

Order Information

Wireless Drop CounterPS-3214



Wireless Temperature Sensor

PS-3201

Welcome to the modern thermometer. The Wireless Temperature Sensor transmits live data and allows students to continuously monitor, log, and plot temperature measurements on nearly any device. When lab-time ends but the experiment continues, students can set the sensor to log data autonomously for days, weeks, or months, then download it for analysis later. This durable, wireless sensor features a stainless steel probe for the most demanding of applications, as well as a battery that lasts over a year*. It can be used in a wide array of experiments and activities because it measures small, but significant temperature changes produced by chemical reactions, convection currents, and even skin temperatures.

Features:

- ▶ Simply pair and go, no cables or adapters to manage
- ▶ Variable sampling rate for capturing small, fast changes or experiments that run for hours, days, or weeks
- ▶ Bluetooth® connectivity and long-lasting coin cell battery
- ▶ Logs temperature data directly onto the sensor for long-term experiments
- ▶ Dust, dirt, and sand-proof and water resistant (IP-X7 certified)

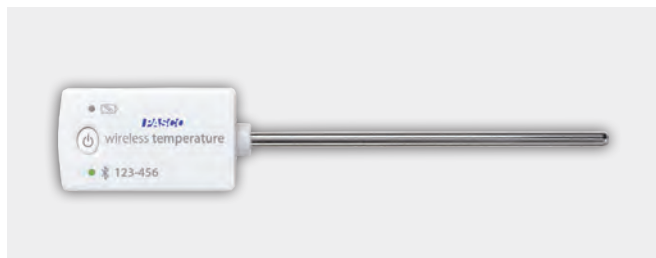

Order Information

Wireless Temperature Sensor.....PS-3201

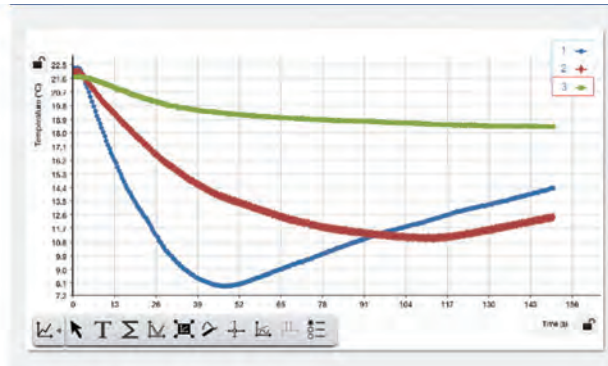

Heats of evaporation indicate strength of intermolecular motion.

Heater Stirrer

PS-3401

This compact hot plate and stirrer has a white ceramic top that is ideal for heating and for seeing color changes when mixing solutions. It has been designed to withstand spills. Its safety features include warning labels and indicator LEDs. And the included rod makes it easy to support sensors.



Order Information

Heater Stirrer.....PS-3401

OHAUS Scout SKX Balance 220g

SE-8823A

The Ohaus Scout SKX digital electronic balances combine range, resolution, and low cost, making them ideal for use in teaching labs.

Simple two-button operation and visual menu prompts allow students to begin weighing with minimal instruction. The large, crisp display is easily viewed from any angle, so teachers can quickly check student results. A sealed front panel, molded spill ring, and removable stainless steel platforms provide protection from spills and make these balances easy to keep clean.

Use Ohaus SKX series electronic balances in conjunction with SPARKvue or PASCO Capstone software. Connect any SKX balance to a computer, tablet or smartphone via Bluetooth® 4.0.



Order Information

OHAUS Scout SKX Balance 220g.....SE-8823A
 Ohaus Bluetooth AdapterSE-8822

Wireless Temperature Sensor Link



PS-3222

The Wireless Temperature Sensor Link enables wireless connection for any PASCO temperature probe with a 3.5 mm connection. The link comes with a Fast Response Temperature Probe, but it can also connect to the Stainless Steel Temperature Probe, Skin/Surface Temperature Probe, the Absolute Zero Sphere, and the Ideal Gas Law Apparatus.



Order Information

Wireless Temperature Sensor Link.....PS-3222

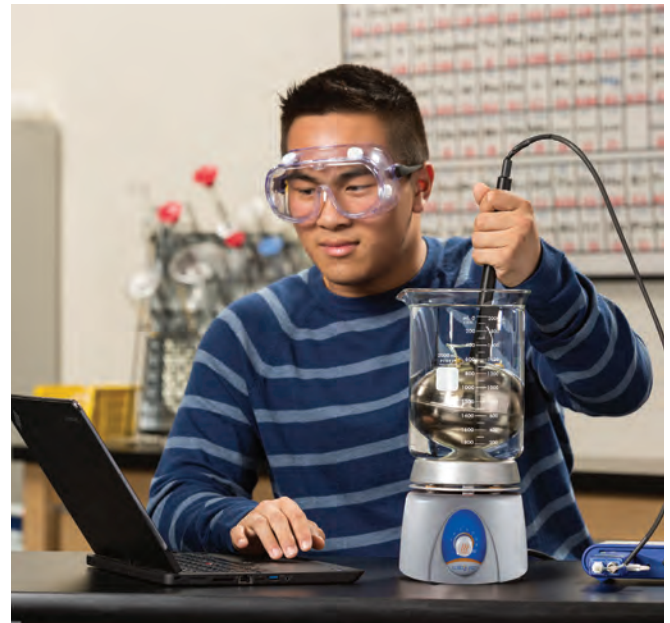

Absolute Zero Sphere

TD-8595

The Absolute Zero Sphere is an effective tool for determining absolute zero temperature. Students connect Pressure and Temperature Sensors before immersing the sphere in water baths of varying temperatures. As the pressure and temperature change, a live graph is generated in PASCO Capstone™. Once the data is collected, students can use a linear fit to extrapolate the value of absolute zero.



Ideal Gas Law Apparatus

TD-8596A

Investigating the Ideal Gas Law is simple using PASCO's Ideal Gas Law Apparatus. By connecting a Pressure Sensor and a Temperature Sensor to the syringe, students can quantitatively look at the relationships between pressure, temperature, and volume.



Includes Ideal Gas Law Syringe, built-in fast response thermistor, with male leuc connector. A Wireless Pressure Sensor (PS-3203) and Wireless Temperature Link (PS-3222) are required for data collection.



Absolute Zero Sphere Connector

Includes built-in fast response thermistor, with male leuc connector. For data collection a Wireless Pressure Sensor (PS-3203) and Wireless Temperature Link (PS-3222) are required.

Order Information

Ideal Gas Law ApparatusTD-8596A

Order Information

Absolute Zero Sphere.....TD-8595



Wireless Pressure Sensor

PS-3203

The Wireless Pressure Sensor allows students to easily collect accurate gas pressure data for a wide range of applications. Included is a 60cc syringe, tubing, and connectors that facilitate experiments such as Boyle's Law and measuring pinch-grip strength. Within PASCO's software, students can easily select their desired units from a list containing kPa, mmHg, inHg, mbar, psi, atm, and torr.

Features:

- ▶ Measures pressure even when the pressure within the system drops below ambient pressure
- ▶ Supports common units (kPa, atm, psi, mmHg, or N/m²) for many applications
- ▶ Bluetooth® wireless connectivity and long-lasting rechargeable battery

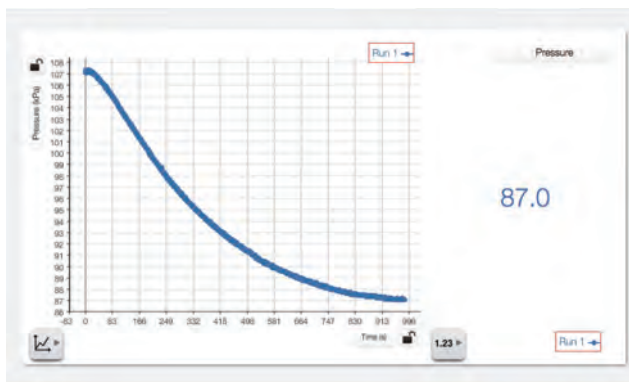

Order Information

Wireless Pressure SensorPS-3203



Wireless Conductivity Sensor

PS-3210

The Wireless Conductivity Sensor measures the electrical conductivity of an aqueous solution. It is ideal for investigating the properties of solutions, including total dissolved solids (TDS) for water quality inquiry. Because it is temperature compensated, calibrations are less frequent and can be applied across a range of temperatures. With a range of 0 to 20,000 $\mu\text{S}/\text{cm}$, this sensor can be utilized for chemical, biological, and environmental studies.

Teacher tip: To measure brackish or marine samples, perform a dilution until the measurement falls within the range, then multiply to determine sample conductivity.

Features:

- ▶ Measure conductivity and total dissolved solids
- ▶ Automatic temperature compensation
- ▶ Battery life >1 year
- ▶ Remote logging with built-in memory
- ▶ Dust-proof, sand-proof, and water-resistant (1 meter for 30 minutes)

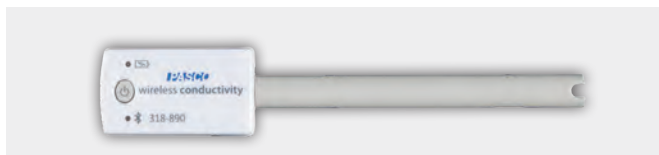
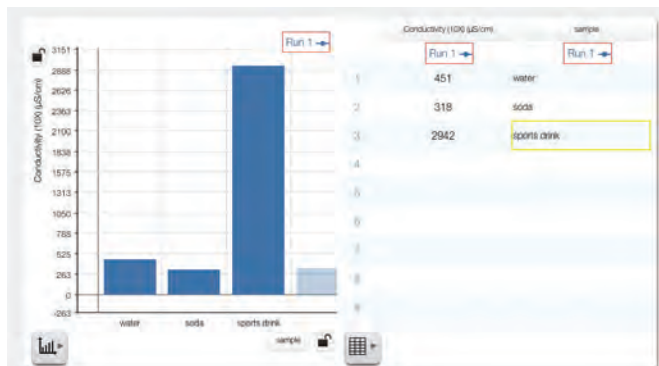

Order Information

Wireless Conductivity SensorPS-3210



Wireless Voltage Sensor

PS-3211

The Wireless Voltage Sensor helps chemistry students investigate redox reactions, electrolytic cell potentials, and the impact solution strength on these generated potentials. By testing potential differences between two half reactions, separated by a salt bridge, students can begin to understand the driving forces behind modern batteries.

Features:

- ▶ **Two Ranges:** ± 15 V, ± 5 V
- ▶ **Resolution:** 7 mV (± 15 V range); 2 mV (± 5 V range)
- ▶ Bluetooth® sampling rate of 1 kHz
- ▶ Higher speed sampling via USB
- ▶ Remote logging



Order Information

Wireless Voltage Sensor.....PS-3211



Wireless Current Sensor

PS-3212

Current sensors enable chemistry students to count the electrons involved in driving reactions, much like how a scale accounts for mass in reactions. Amperage determines how many atoms are involved in a chemical reaction. Since the two are related, current can be used to find out how much reactant is available in a solution. Integrating currents keeps track of how much metal might electroplate onto an electrode.

Features:

- ▶ **Two Ranges:** ± 1.0 A and ± 0.1 A
- ▶ **Resolution:** 0.2 mA at ± 1 A range and 0.02 mA at ± 0.1 A range
- ▶ Bluetooth® sampling rate of 1.0 kHz
- ▶ High-speed sampling via USB
- ▶ Remote logging
- ▶ Variable sampling rate for recording small, fast changes or experiments that run for hours, days, or weeks

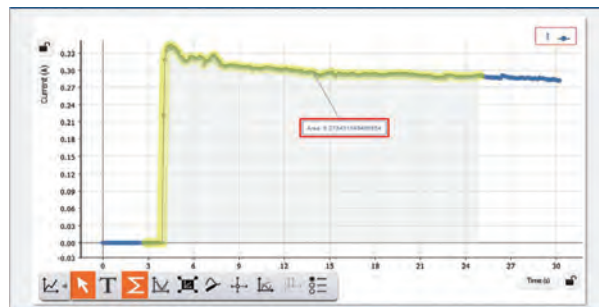

Order Information

Wireless Current SensorPS-3212



Molecular Model Set

PS-3400

The Molecular Model Set is the perfect tool to help students understand core science concepts such as chemical formulas, equation balancing and the conservation of mass. They are critical to making more advanced concepts easier to visualize and allow students to predict polarity and study reaction mechanisms. Students can explore intermolecular attractions, steric hindrances, nomenclature and complex structure. Anything is possible for students, from creating simple water or carbon dioxide molecules to complex biochemicals such as amino acids and lipids. The set is ideal for studying Chemistry and Biochemistry.



Order Information

Molecular Model Set.....PS-3400



Wireless Geiger Counter



NEW

PS-3238

The PASCO Wireless Geiger Counter counts beta, gamma and alpha radiation particles as they enter the Geiger-Müller detector tube inside the counter. Designed for easy mounting, the Geiger Counter provides superior position control in inverse square law labs, as well as an audible beep to indicate the detection of ionizing radiation. The front plastic snout fits conveniently inside the NU-3344 Sample Holder stand (available separately), which stabilizes the front of the counter's detector tube exactly 1 cm from the first slot in the holder.

With the Wireless Geiger Counter, students can wirelessly control the high voltage supplied to the Geiger-Müller tube inside the counter, enabling them to make measurements of counts/interval for different tube voltages. They can also plot counts/interval versus tube voltages to experimentally observe the Geiger plateau characteristics of the tube.

Features:

- ▶ Built-in metal mesh screen to protect the delicate mica window in the front of the Geiger-Müller detector tube
- ▶ Audible beep count indication that is easily switched on or off
- ▶ **Versatile positioning options:** either in the NU-3344 Sample Holder, hand-held, or mounted on a rod stand
- ▶ Convenient design to natively fit the PASCO NU-3344 Sample Holder
- ▶ Provides wireless control over the high voltage supplied to the Geiger-Müller tube inside the counter for Geiger plateau experiments

Includes:

- Wireless Geiger Counter
- Micro USB Cable: PS-3584
- Threaded handle for mounting the sensor to a ring stand



Order Information

Wireless Geiger Counter.....PS-3238

Geiger Counter Sample Holder.....NU-3344



Wireless Polarimeter

PS-3237

The Wireless Polarimeter has both Bluetooth® and USB connectivity, making it possible to analyze chiral compounds with your iPad®, Chromebook™, Android tablet, or computer. It is ideal for introductory experiments in Organic and Biochemistry, where chiral compounds are of special interest.

PASCO's Wireless Polarimeter passes plane polarized light through a vertical sample, which contains a chiral compound, followed by an analyzer and detector. The optical rotation is determined by finding the angle between the starting position and the location where the optimum light level transmits through the cross polarizer. Students can use the rotation data to calculate the concentration of a chiral sample, while the specific rotation (amount turned per g/ml dissolved) is an intrinsic property that can be used to differentiate molecules or determine racemic mixtures.

Specifications:

- ▶ **Connectivity:** Bluetooth and USB
- ▶ **LED light source:** 589 nm
- ▶ **Optical Rotation Accuracy:** $\pm 0.09^\circ$
- ▶ **Cell Length:** 101.3mm \pm 0.8mm

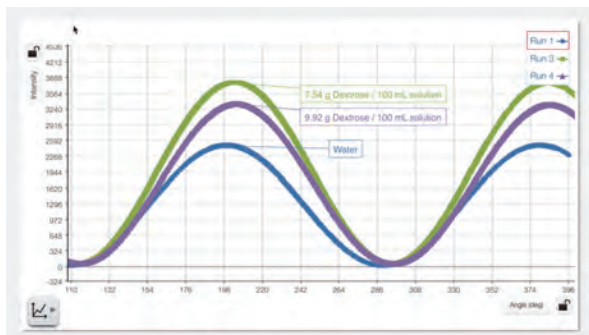

Order Information

Wireless PolarimeterPS-3237



Polarizer Demonstrator

OS-9477A

Confirm Malus' Law using the Polarizer Demonstrator and a Light Sensor. The angle is read directly from the polarizer, which is marked in 5° increments. Any light source can be used, but the experiment works especially well with the PASCO Color Mixer (OS-8496). See pasco.com for more information.



Introduce the concept of polarization with this colorful and meaningful demonstration.

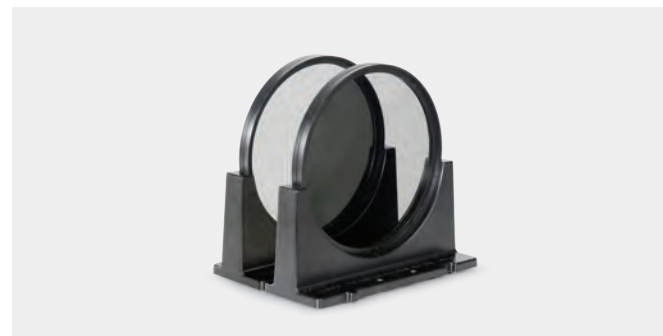

Order Information

Polarizer DemonstratorOS-9477A



Wireless Colorimeter & Turbidity Sensor

PS-3215

The Wireless Colorimeter & Turbidity Sensor simultaneously measures the absorbance and transmittance of six different wavelengths. The sensor can be used to study Beer's Law (absorbance vs. concentration), enzyme activity, photosynthesis, and the rates of chemical reactions (absorbance vs. time). After a simple calibration, students can quickly begin viewing live measurements as they materialize across the visible spectrum at 650 nm (red), 600 nm (orange), 570 nm (yellow), 550 nm (green), 500 nm (blue), and 450 nm (violet).

This sensor also functions as a high-quality turbidimeter for water quality analysis. Rather than simply measuring transmitted light, the Wireless Colorimeter and Turbidity Sensor measures light scattered at a 90 degree angle from the sample, resulting in accurate and repeatable measurements. Additionally, the internal housing for the cuvette is opaque, which limits ambient light interference to preserve accuracy.

Features:

- ▶ Stabilized light source for consistent readings
- ▶ Measures six different wavelengths simultaneously
- ▶ PASCO software displays the absorbance & transmittance at each wavelength in the appropriate color
- ▶ Directly calibrated to read EZsnap concentrations of Ammonia, Nitrate, Phosphate, Iron and Chlorine in ppm.
- ▶ Functions as both a colorimeter and turbidimeter

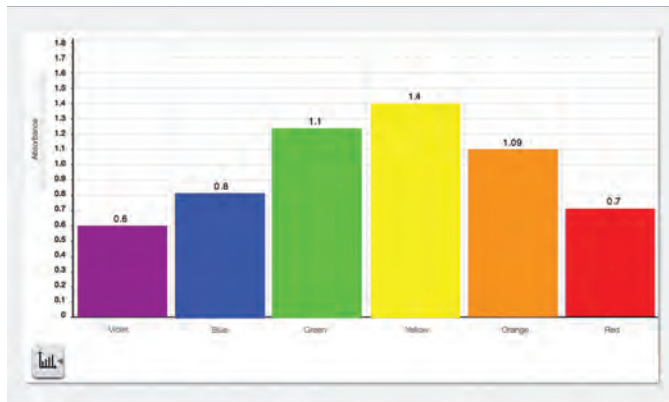

Measure the absorbance and transmittance of a solution at six different wavelengths... simultaneously!

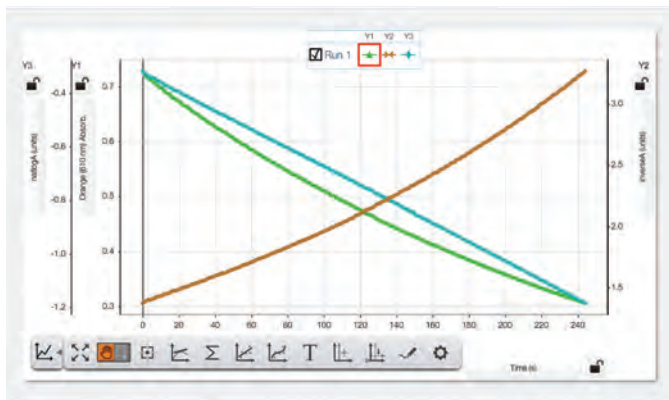

Graphically analyze how a reaction changes over time. Use SPARKvue to visualize multiple measurements on the same graph.

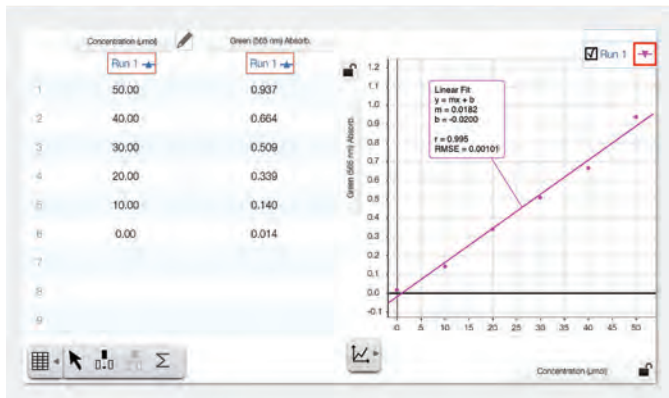

Cuvettes and Caps

SE-8739

Set of 100 identical 3.5-mL polystyrene cuvettes and caps. Transparent to visible light.



Order Information

Wireless Colorimeter & Turbidity Sensor.....PS-3215

Order Information

Cuvettes and Caps.....SE-8739



Wireless Spectrometer (VIS)

PS-2600

The Wireless Spectrometer from PASCO is specifically designed for modern chemistry, biology, and physics labs. With Bluetooth and USB connectivity, students can quickly connect from their device or computer using the free PASCO Spectrometry Software. Scan times are fast, allowing students to gather a full spectrum of data in under one second. After specifying a target wavelength, students can study concentrations (Beer's Law), rates of reactions, or investigate emission spectra using the optional fiber optic cable.

Perform these labs with the PASCO Wireless Spectrometer:

- ▶ Emission Spectra of Light
- ▶ Absorbance Spectra
- ▶ Beer's Law
- ▶ Kinetics
- ▶ Fluorescence



Order Information

Wireless Spectrometer (VIS).....PS-2600
Includes USB Charging cable, 10 cuvettes, and Spectrometry Software.

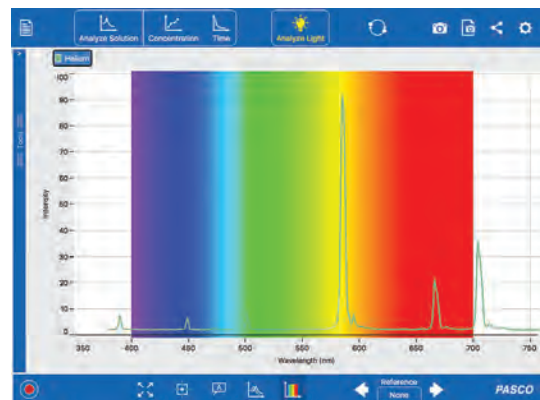

Analyze light sources with the optional Fiber Optic Cable. Easily compare the spectrum to known reference lines in the software.

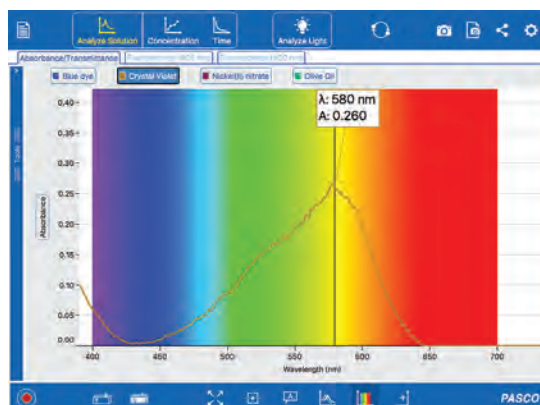

Full visible spectrum includes a large digits display that helps students select wavelengths and determine absorbance values.

Spectrometer Comparison

Compare the features and capabilities and see which spectrometer works best in your lab.



Colorimeter & Turbidity
PS-3215



PASCO SPECTROMETER
PS-2600



PASCO UV-VIS SPECTROMETER
SE-3607

Feature	Colorimeter & Turbidity	PASCO Spectrometer	UV-VIS Spectrometer
Light Source	White LED	RGB LED-Boosted Tungsten	Deuterium (UV) Tungsten (Vis)
Optical Resolution	5 nm width color	2-3 nm FWHM	-1.5 nm
Wavelength Range	450, 500, 550, 570, 600, 650 nm	380 - 950 nm	180 - 1050 nm
Wavelength Accuracy	± 25 nm	± 3 nm	± 1 nm
Photometric Range (for best accuracy)	0.05 to 1.5	0.1 to 2.0	0.1 to 1.0
Photometric Accuracy	± 5%	± 5%	± 5%
Full Spectrum Scans	No	Yes	Yes
Scan Time	N/A	4 ms - 10 s	4 ms - 10 s
Connects via USB	Yes	Yes	Yes
Connects via Bluetooth	Yes	Yes	No
Rechargeable battery (for cordless operation only)	Yes	Yes	No
Fluorescent Excitation	No	405, 500 nm	No
Works with SPARKvue & Capstone Software	Yes	No	No
Works with PASCO Spectrometry Software	No	Yes	Yes
Data Storage/Onboard Memory	Yes	No	No
Good for Field Use	Yes	Yes	N/A
Turbidimeter	Yes	No	No



UV-Vis Spectrometer

SE-3607

The SE-3607 is an easy-to-use, wide range UV-Vis spectrometer that delivers fast, accurate and reliable performance for routine analyses in chemistry and biochemistry teaching labs. With USB connectivity and cross-platform Spectrometry Software, the PASCO UV-Vis Spectrometer improves collaboration between lab members, enabling data collected on a computer or laptop to be analyzed on tablets, iPads, and Chromebooks. Additional accessories, such as the UV-Vis Fiber Optic Kit, can be used to extend the spectrometer's capabilities for the analysis of emission spectra, light sources, and the classification of lasers.

Highlights:

- Award-winning Spectrometry software
- Free, multi-platform Spectrometry app
- One-click light and dark calibrations
- Fast warm-up time (<10 minutes)
- Adjustable scan averaging, signal integration time and smoothing
- Graphs absorbance across the entire spectra with each scan
- Graphs Absorbance vs. Concentration (Beer's Law)
- Graphs Absorption vs. Time (kinetics)
- Allows bandwidth averaging and variable sample rate time graphs

Applications:

- ▶ Determination of solution concentrations
- ▶ Identification of unknown substances
- ▶ Measurement of reaction rates or rate of decay
- ▶ Colorimetric assays (e.g., BCA, Bradford, Lowry)
- ▶ Purity testing of synthesized compounds
- ▶ Determination of the equilibrium constant
- ▶ Determination of molar absorption coefficients
- ▶ Quality testing (e.g., fermentation mediums, food adulteration, QA levels)

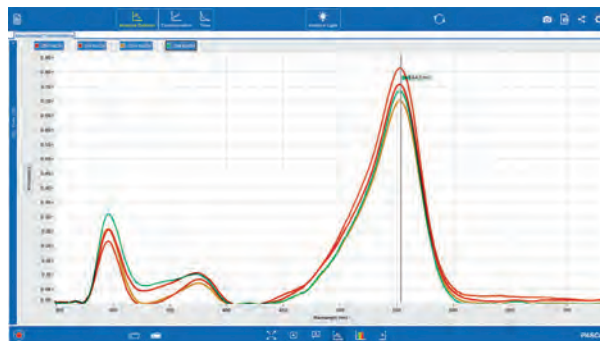

Absorbance of solutions containing various amounts of NaOH.

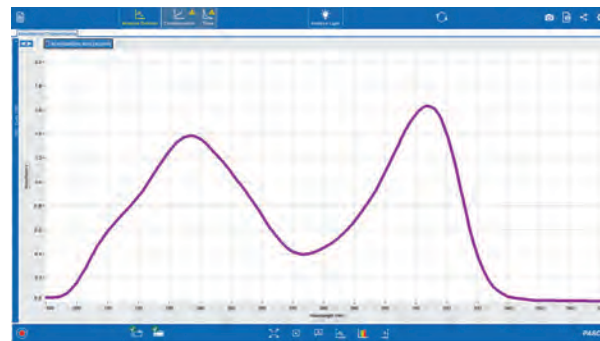

Absorbance of Aspirin.

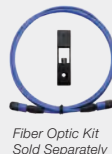
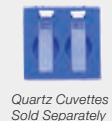

For Mac® and Windows® Computers go to pasco.com/downloads

Order Information

UV-Vis Spectrometer.....SE-3607
 UV-Vis Fiber Optic Kit.....SE-7182

UV Quartz Cuvettes (Qty. 2)SE-3611
 Disposable UV Semi-Micro Volume Cuvettes (Qty. 10) SE-3610

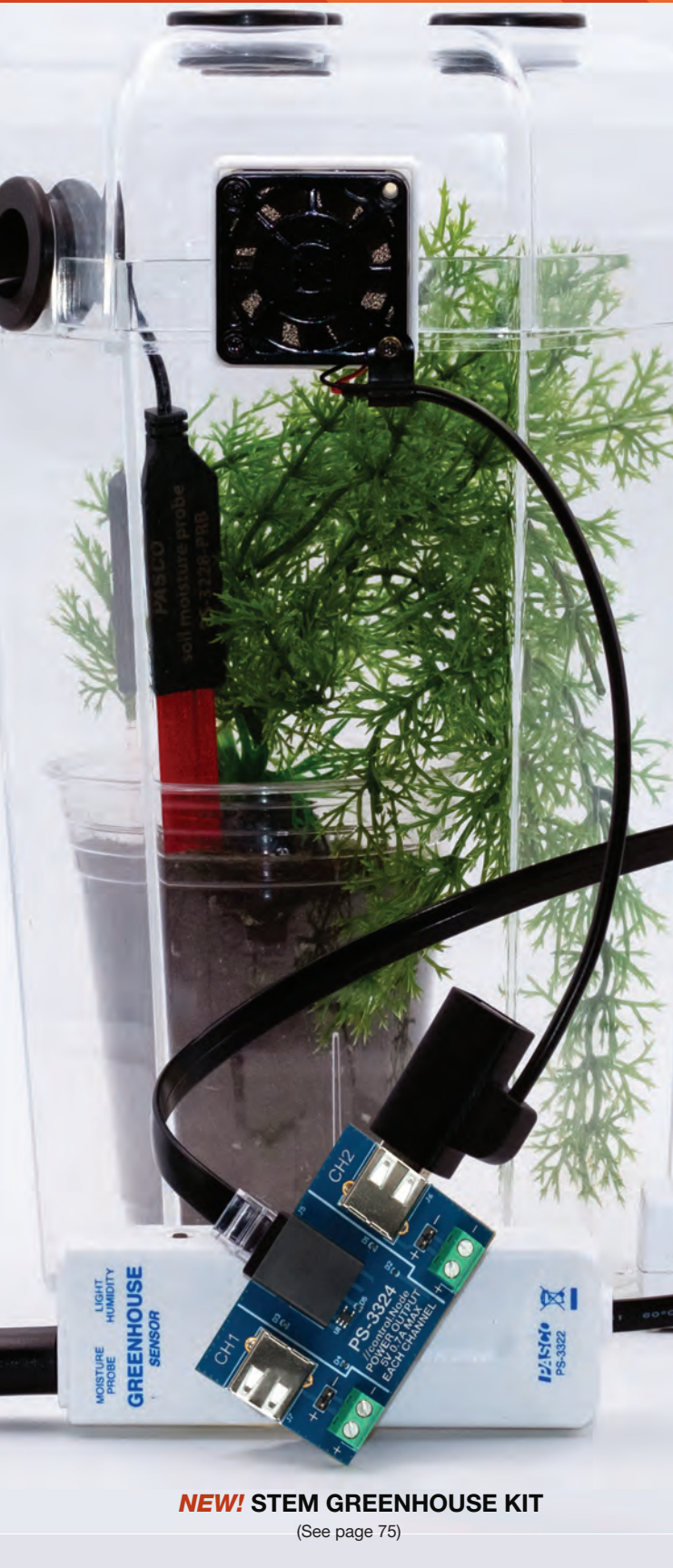

NEW! STEM GREENHOUSE KIT

(See page 75)

PASCO's Integrated Solutions for Environmental Science

Facilitate discovery-based environmental inquiry in your classroom with PASCO. We offer cutting-edge solutions for both general and advanced Environmental Science classes, as well as Ag Science. Using our award-winning wireless sensors and SPARKvue software, students can collect and analyze data and see their lab results, all in real time and on their own devices. Our wireless sensors are rugged, suitable for use inside or outside the classroom, and have a long battery life. These sensors are powerful tools for environmental monitoring and experimentation anytime, anywhere. And our free digital labs may provide the exact lab investigation you have been seeking!

Environmental Science Index

AG Science Starter Lab Station.....	67
Advanced Environmental Science and Lab Stations .	68
CO ₂ , Soil Moisture.....	70
Weather with GPS, Weather Vane Accessory.....	71
Temperature, pH.....	72
Conductivity, Light	73
Density Model and Dissolved Oxygen Sensor	74
EcoZone System, Greenhouse Kit.....	75
Water Quality Testing, ezSample Kits.....	76
Water Quality and Flow Rate Sensors	77



World Class Support & Professional Development
Committed to Your Success

CONTACT US TODAY
www.pasco.com

AG Science Starter Lab Station

EB-6336

The Agricultural Science Starter Lab Station makes it easy and affordable to begin using sensor-based technology in your classroom or home. Inside the Starter Lab Station are the wireless sensors used to perform 10 agriculture labs. Using these 10 lab printouts, students can investigate soil and water quality, greenhouse gases, cellular processes of diffusion in plants, respiration and photosynthesis. Students will also work to extract and separate pigments from leaves, determine the energy content stored in plant-based food materials, and model ecosystems using factors that create challenging and optimal growing conditions.



AG Science Lab Manual

The following is a complete list of lab activities from PASCO's online Agricultural Science Lab Manual. You may preview and download individual student lab activities and SPARKvue data files, view AP/IB correlations, and access the Teacher Files by creating or signing in to a free PASCO account. Browse and download AG science labs for free at pasco.com.

AG Science Station Lab Titles

The AG Science Starter Lab Station supports 7 of the 10 labs. Add the Extension Lab Station* to do all 10 lab titles.

Determining Soil Quality

Water Treatment

Freshwater Quality Monitoring*

Respiration of Germinating Seeds

Plant Pigments & Photosynthesis

Plant Respiration & Photosynthesis

Modeling an Ecosystem*

Greenhouse Gases*

Energy Content of Food

Diffusion

- Determining Soil Quality
- Water Treatment
- Freshwater Quality Monitoring
- Water and pH
- Respiration of Germinating Seeds
- Plant Pigments and Photosynthesis
- Plant Respiration and Photosynthesis
- Modeling an Ecosystem
- Greenhouse Gases
- Energy Content of Food
- Diffusion
- Soil and pH



Shown here: AG Science Starter Lab Station

The AG Science Starter Lab Station includes a lab manual and these wireless sensors and apparatus:

- ▶ Temperature
- ▶ pH
- ▶ CO₂
- ▶ Conductivity
- ▶ Colorimeter & Turbidity
- ▶ Storage Case

**To do the remaining 3 labs from the AG Science Lab Manual (listed above), add the Extension Lab Station (see page 51). Add the AG Science Teacher Lab Manual to perform an additional 4 AG science labs.*

Order Information

Agricultural Science Starter Lab StationEB-6336

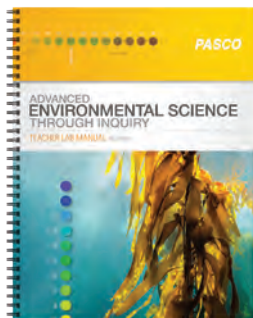

Advanced Environmental Science Through Inquiry Labs for AP[®] & IB[®]

PASCO's Advanced Environmental Science Through Inquiry Teacher Lab Manual contains 20 labs that have been specifically designed to support student inquiry, as well as AP[®] and IB[®] curriculum*. This manual is available in both a print version and an all-digital version.

- ▶ Easy and meaningful data collection leads to increased time for data analysis and open inquiry.
- ▶ Includes sample data for investigations and inquiry, answers to analysis and synthesis questions, an assessment rubric, teacher tips, lab preparation information, and more.

- ▶ Most labs can be completed in one lab session with readily available materials, including the sensor bundles on the opposite page.
- ▶ Labs integrate high-order analysis and synthesis questions.
- ▶ The flexible format provides guided inquiry opportunities and scaffolding, so students can create their own experiments.

Note: Labs use a variety of structured, guided and open inquiry approaches. Students can explore focused to self-driven concepts of environmental interest.

Advanced Environmental Science Through Inquiry Labs and Sensors Used

Lab Title

Lab Title	Starter Bundle				Extension Bundle				AP [®] Big Ideas*	IB [®] Connections*
	Weather with GPS	Temperature	pH	Conductivity	Optical Dissolved Oxygen	CO ₂	Colorimeter	EcoZone		
1. Determining Soil Quality			●	●		●			1,2	5.1, 5.2, 5.3
2. Insolation and the Seasons		●							1	1.2
3. Investigating Specific Heat		●							1	1.2, 2.3
4. Monitoring Microclimates	●								4	7.1, 7.2, 7.3
5. Sunlight Intensity and Reflectivity	●	●							1	2.3, 7.1-7.3
6. Tracking Weather	●								1	7.2, 7.3
7. Earth's Magnetic Field**									1	1.2
8. Radiation Energy Transfer		●							1	1.2, 2.3
9. Seafloor Spread Plate Tectonics**									1	1.2
10. Modeling an Ecosystem	●	●	●	●	●	●			2	1.2, 2.4, 2.5, 3.1
11. Photosynthesis and Primary Productivity					●				1, 2	1.1, 1.2, 2.3, 5.2
12. Photosynthesis and Cell Respiration		●				●			1, 2	1.1, 1.2, 2.3, 5.2
13. Cellular Respiration and Carbon Cycle						●			1	1.1, 1.2, 6.1, 6.2
14. Energy Content of Food		●							1	1.3, 2.3
15. Weather in a Terrarium	●								1, 2	1.1, 1.2, 7.2, 7.3
16. Yeast Respiration		●			●	●			1, 2	1.1, 1.2
17. Properties of Water		●							1	4.1, 4.2
18. Air Pollution and Acid Rain			●						4	6.1, 6.2, 6.3, 6.4
19. Monitoring Water Quality	●	●	●	●	●		●		4	4.1, 4.2, 4.4
20. Toxicology Using Yeast			●			●			2	1.1, 1.2
21. Water Treatment			●	●			●		4	4.1, 4.2, 4.4
22. Greenhouse Gases		●					●		4	6.1, 6.2, 6.3, 6.4

*AP is a registered trademark of the College Board, which was not involved in the production of, and does not endorse, this product. IB is a registered trademark of the International Baccalaureate Organization, which was not involved in the production of, and does not endorse, this product.

**Requires Wireless 3-Axis Magnetic Field Sensor; see opposite page.

AG Science Lab Stations Support Advanced Environmental Science Investigations

The AG Science Starter Lab Station and Extension Station, together with PASCO's *Advanced Environmental Science Through Inquiry Lab Manual*, offer a truly complete solution. With over 20 sensor-based labs covering a range of Environmental and Advanced Environmental topics and all of the equipment and apparatus required to conduct the labs hands-on, inquiry with data collection and analysis has never been easier or more affordable. For investigations in water quality, add the Water Quality Field Guide and extend your investigations.



NEW



Water Quality Field Guide

PS-2829A

The Water Quality Field Guide is a combination 'how-to' and 'why?' reference. It covers how to plan for and successfully measure water quality in the field, and it explains why these measurements are important and what they mean.

AG Science Station Lab Titles
Together, the AG Science Starter and Extension Lab Stations support over 20 Advanced Environmental labs. Conduct the 10 labs below right out of the box.

1. Determining Soil Quality
2. Water Treatment
3. Freshwater Quality Monitoring
4. Respiration of Germinating Seeds

5. Plant Pigments & Photosynthesis
6. Plant Respiration & Photosynthesis
7. Modeling an Ecosystem
8. Greenhouse Gases
9. Energy Content of Food
10. Diffusion

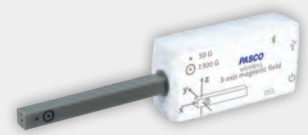

Wireless Magnetic Field Sensor

PS-3221

This 3-Axis Magnetic Field Sensor can sense the Earth's magnetic field and fields from coils and bar magnets. There are two ranges: ±50 gauss and ±1300 gauss. This sensor is primarily for static fields.



Shown here: AG Science Starter and Extension Lab Stations

The AG Science Starter & Extension Lab Stations include these wireless sensors and materials:

- ▶ Temperature
- ▶ Conductivity
- ▶ pH
- ▶ CO₂
- ▶ Colorimeter
- ▶ Turbidity
- ▶ Optical Dissolved Oxygen
- ▶ Weather with GPS
- ▶ EcoZone System
- ▶ Lab Manual
- ▶ Storage Case

Order Information

Advanced Environmental and Earth Sciences Teacher Guide.....PS-2979	Water Quality Field Guide.....PS-2829A
Agricultural Science Starter Lab Station.....EB-6336	Wireless Magnetic Field Sensor.....PS-3221
Agricultural Science Extension Lab Station.....EB-6337	



CO₂ Sensor shown in use with Dissolved CO₂ Waterproof Sleeve.

Wireless CO₂ Sensor

PS-3208

Measure changes in carbon dioxide (CO₂) gas levels quickly and easily with the Wireless CO₂ Sensor. The sensor is temperature compensated and can operate in high humidity environments, like the included 250-mL sample bottle. This sensor employs live data to make core labs, such as photosynthesis, cellular respiration, and metabolism experiments engaging and impactful. With the ability to store more than 55,000 data points, this sensor enables studies to run overnight or throughout an entire weekend for long-term carbon cycling investigations.

Features:

- ▶ Logging ability for long-term experiments, store up to 55,000 data points
- ▶ Integrated stopper for use with sample bottle and common glassware
- ▶ Temperature compensated for accurate results



The sleeves are waterproof but allow CO₂ gas to pass through the membrane, creating a headspace around the sensor.

Order Information	
Wireless CO ₂ Sensor	PS-3208
Dissolved CO ₂ Waterproof Sleeve	PS-3545

Wireless Soil Moisture Sensor **NEW**

PS-3228

The Wireless Soil Moisture Sensor measures the volumetric water content (%VWC) of soil, reporting data in real time or storing it onboard the sensor's memory for long-term experiments. Durable and easy to use, the Wireless Soil Moisture Sensor is the perfect tool for monitoring controlled experiments in the classroom and long-term experiments outdoors. From experiments in evaporation and soil composition to water consumption and plant competition, the Wireless Soil Moisture Sensor makes it easy for students to investigate a wide array of topics through real-time or long-term data collection.

Features:

- ▶ Collect and display data in real time within PASCO Capstone or SPARKvue software
- ▶ Automate data collection for hours, days, or weeks with Logging Mode
- ▶ Bluetooth connectivity enables use in the classroom, lab, or field
- ▶ Supports use of GPS data from a mobile device for GIS mapping activities
- ▶ Selectable calibrations for predominantly sandy soils, clay soils, and loamy soils



Order Information	
Wireless Soil Moisture Sensor	PS-3228



Wireless Weather Sensor with GPS

PS-3209

The Wireless Weather Sensor is an all-in-one instrument for monitoring complex environmental conditions. It houses several sensing elements within a single unit to provide 19 different measurements. Use the sensor in logging mode with the Weather Vane Accessory for long-term monitoring, or use it as a handheld instrument to study microclimates and record ambient conditions relevant to environmental phenomena. You can wirelessly export data to your device for classroom analysis and group activities that are constrained by time. With the built-in GPS, you can collect location data for student investigations and analyze it on the map display, powered by ESRI ArcGIS, within SPARKvue software.

Features:

- ▶ Logging mode for long-term experiments
- ▶ Water resistant for extended environmental monitoring
- ▶ Built-in light sensor for measuring light level and UV index
- ▶ Map display (in SPARKvue software) for analyzing spatial data
- ▶ 19 different measurements that can be collected and analyzed individually or simultaneously
- ▶ GPS enables data from any PASCO probe to be viewable on a map, when connected.

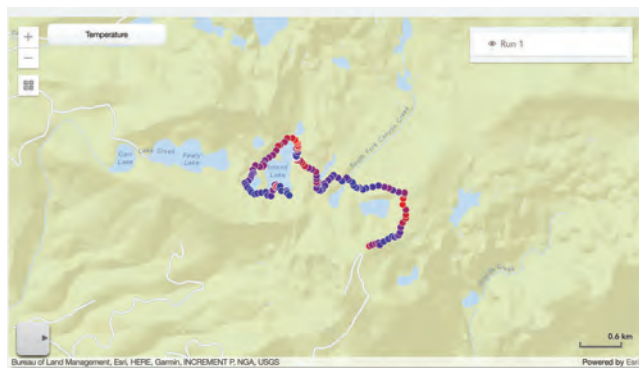

With ESRI's ArcGIS online you can visualize data in seconds with a FREE account!

Measurements

Weather

1. Ambient Temperature
2. Barometric Pressure
3. Wind Speed
4. Wind Direction (true)
5. Relative Humidity
6. Absolute Humidity
7. Dew Point
8. Wind Chill
9. Heat Stress Index

Light

10. Ambient Light (lux)
11. UV Index
12. PAR
13. Irradiance

GPS

14. Latitude
15. Longitude
16. Altitude
17. Speed
18. Magnetic Direction
19. True Direction



The weather dashboard displays data from the multiple sensors.



Weather Vane Accessory sold separately.



Order Information

- Wireless Weather Sensor with GPSPS-3209
- Weather Vane AccessoryPS-3553



Wireless Temperature Sensor

PS-3201

Welcome to the modern thermometer. The Wireless Temperature Sensor transmits live data and allows students to continuously monitor, log, and plot temperature measurements on nearly any device. When lab-time ends but the experiment continues, students can set the sensor to log data autonomously for days, weeks, or months, then download it for analysis later. This durable, wireless sensor features a stainless steel probe for the most demanding of applications, as well as a battery that lasts over a year*. It can be used in a wide array of experiments and activities because it measures small, but significant temperature changes produced by chemical reactions, convection currents, and even skin temperatures.

Features:

- ▶ Simply pair and go, no cables or adapters to manage
- ▶ Variable sampling rate for capturing small, fast changes or experiments that run for hours, days, or weeks
- ▶ Bluetooth® connectivity and long-lasting coin cell battery
- ▶ Logs temperature data directly onto the sensor for long-term experiments
- ▶ Dust, dirt, and sand-proof and water resistant (IP-X7 certified)



Wireless pH Sensor

PS-3204

The Wireless pH Sensor is a must-have for any chemistry, biology, or environmental science course. Equally capable in the lab or field, the sensor eliminates the hassle of cables, reducing spills and improving safety. Plus, it rarely requires charging; the sensor's coin cell battery lasts for 2-3 years in most labs and costs about one dollar to replace. It can transmit data in real time, or store data for days when continuous monitoring is required. The Wireless pH Sensor enhances countless activities, including acid-base titrations, investigations into household chemicals, analyses of chemical reactions, water quality studies, and much more.

Features:

- ▶ Simply pair and go, no cables or interfaces to manage
- ▶ Compatible with ion-selective electrodes (ISE) and the oxidation reduction probe (ORP)
- ▶ Bluetooth® connectivity and a long-lasting coin cell battery
- ▶ Logs pH data directly onto the sensor for long-term experiments
- ▶ Wirelessly connects to SPARKvue and Capstone for intuitive analysis and lab reports

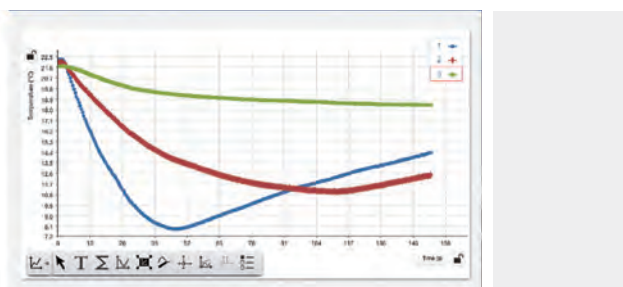

Measure the pH of water in different locations and annotate with text and pictures.



Order Information

Wireless Temperature Sensor.....PS-3201

Order Information

Wireless pH Sensor.....PS-3204



Wireless Conductivity Sensor

PS-3210

The Wireless Conductivity Sensor measures the electrical conductivity of an aqueous solution. It is ideal for investigating the properties of solutions, including total dissolved solids (TDS) for water quality inquiry. Because it is temperature compensated, calibrations are less frequent and can be applied across a range of temperatures. With a range of 0 to 20,000 $\mu\text{S}/\text{cm}$, this sensor can be utilized for chemical, biological, and environmental studies.

Teacher tip: To measure brackish or marine samples, perform a dilution until the measurement falls within the range, then multiply by that factor to determine sample conductivity.

Features:

- ▶ Measure conductivity and total dissolved solids
- ▶ Automatic temperature compensation
- ▶ Battery life >1 year
- ▶ Remote logging with built-in memory
- ▶ Dust-proof, sand-proof, and water-resistant (1 meter for 30 minutes)

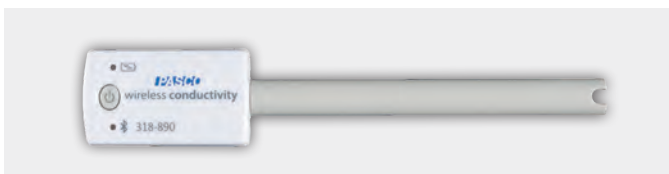
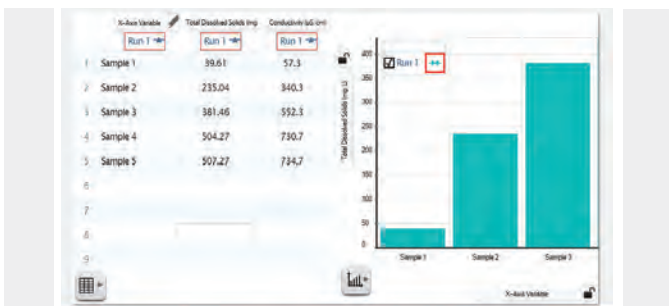

Order Information

Wireless Conductivity SensorPS-3210



Wireless Light Sensor

PS-3213

The Wireless Light Sensor features two separate apertures - one for ambient light measurements and one for directional light measurements. The ambient sensor measures illuminance and UV Index, while the spot (directional) aperture measures light level and color intensity. Our software displays the relative intensities of Red, Green, and Blue light, then sums them to determine the level of White light. PAR and irradiance are also available as calculated measurements within PASCO Capstone (version 1.8 or later) and SPARKvue software (version 2.6 or later).

Features:

- ▶ Wirelessly connects to computers, Chromebooks, tablets, and smartphones
- ▶ Simply pair and go, no cables or adapters to manage
- ▶ On-board memory enables the sensor to function as an independent datalogger
- ▶ Variable sampling rate for short, precise experiments or lengthy, multi-day data collection.
- ▶ Bluetooth connectivity and long-lasting coin cell battery
- ▶ Indirect PAR measurements for biological studies

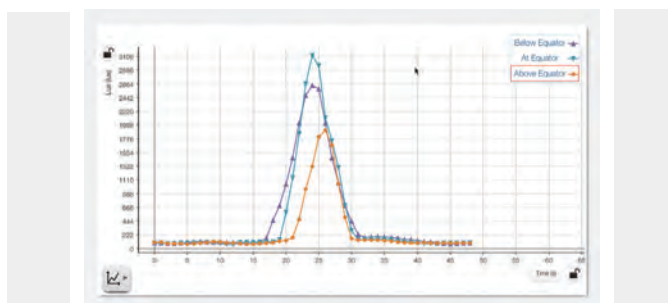

Order Information

Wireless Light SensorPS-3213



Density Circulation Model

ME-6816

The PASCO Density Circulation Model allows students to model, measure and understand the complex density-driven circulation associated with heat transfer through convection. Students can recreate vertical ocean currents driven by water bodies with density differences. They can extend this learning by using sensors to collect data and create graphs showing the thermocline, halocline and pycnocline using a Salinity Sensor PS-2195 (next page).

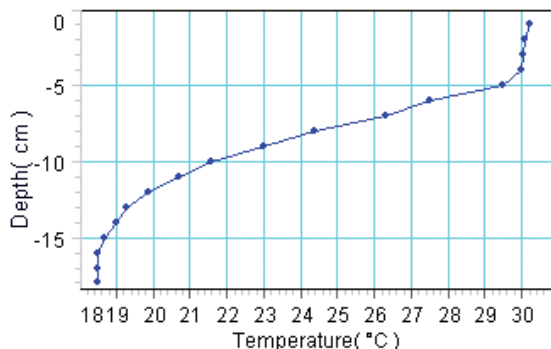

Wireless Optical Dissolved Oxygen Sensor

PS-3224

The Wireless Optical Dissolved Oxygen (ODO) Sensor is ideal for monitoring DO₂ in the lab or field. The Wireless Optical DO Sensor contains three different probes. In addition to the dissolved oxygen sensor, it also includes probes for measuring atmospheric pressure and water temperature. The optical technology is accurate, fast, and does not require stirring, filling solutions, warm-up, or frequent calibration. When equipped with the included cover, the sensor has a waterproof design and is submersible to a depth of 10 m.

A PASCO exclusive feature allows you to log data using the sensor's built-in memory. After collecting data for hours or even days, simply connect the sensor to your device and you're ready to download your data. With this powerful sensor, educators can explore day and night nutrient cycles, changes in metabolic processes, seasonal changes in water quality, and more.

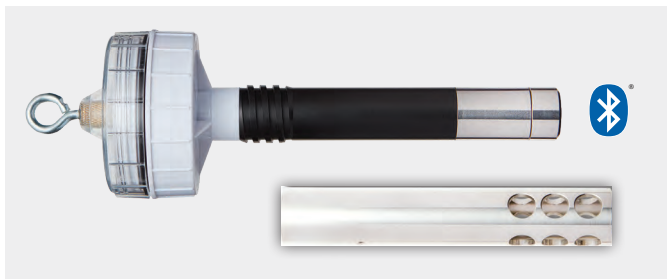

Wireless Optical Dissolved Oxygen Sensor Metal Guard

PS-3604

This metal guard protects the sensing element of the Wireless Dissolved Oxygen Sensor. It also helps weigh the sensor down when making measurements under water.

Order Information

Density Circulation ModelME-6816

Order Information

Wireless Optical Dissolved Oxygen SensorPS-3224

Wireless Optical Dissolved Oxygen Sensor Metal Guard PS-3604



EcoZone System

ME-6668

PASCO's EcoZone System is designed to help students model and understand complex interactions within, and among, different ecosystems. The three clear, acrylic EcoChambers are specially designed to accommodate PASCO sensors, making qualitative and quantitative measurements easily accessible.

With three interconnected chambers, students can model interactions between three different ecosystems. Choose the traditional terrestrial, aquatic, and decomposition environments, or create unique biomes to model and measure. With the EcoZone System, students can create two identical ecosystems for precise control of variable impact, decouple the system for isolated investigations, or connect all three chambers to study interactions.

Features:

- ▶ Total volume of each chamber is 4,534 cm³
- ▶ Sturdy construction designed for easy setup and cleanup
- ▶ Quantitatively study the interaction of different ecosystems
- ▶ Custom molded for use with PASCO sensors
- ▶ Clear acrylic allows for observations from all sides

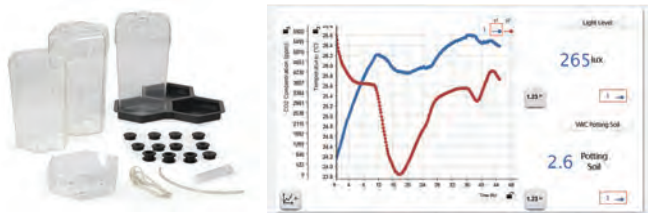

Order Information	
EcoZone System	ME-6668



Greenhouse Sense & Control Kit

NEW

ST-2997

Designed for the exploration of biological and ecological concepts, the Coding with Greenhouse Sensor Technologies Kit includes everything students need to design, build, program, and study their very own greenhouse.

Build career awareness with activities that make real-world connections to:

- ▶ Agricultural monitoring
- ▶ Ecological management
- ▶ Plant physiology

Help students develop competency in:

- ▶ Coding
- ▶ Problem solving
- ▶ Data collection and analysis
- ▶ Ecological concepts
- ▶ Science & Engineering practices

This complete kit includes: an EcoChamber and //control.Node; a breakout board; a fan; a water pump; tubing with drip-watering ends; a red and blue light; and a Greenhouse Sensor that measures light, temperature, humidity, and soil moisture.



Order Information	
Greenhouse Sense & Control Kit.....	ST-2997



Wireless Colorimeter & Turbidity Sensor

PS-3215

The Wireless Colorimeter & Turbidity Sensor simultaneously measures the absorbance and transmittance of six different wavelengths. The sensor can be used to study Beer's Law (absorbance vs. concentration), enzyme activity, photosynthesis, and the rates of chemical reactions (absorbance vs. time). After a simple calibration, students can quickly begin viewing live measurements as they materialize across the visible spectrum at 650 nm (red), 600 nm (orange), 570 nm (yellow), 550 nm (green), 500 nm (blue), and 450 nm (violet).

This sensor also functions as a high-quality turbidimeter for water quality analysis. Rather than simply measuring transmitted light, the Wireless Colorimeter and Turbidity Sensor measures light scattered at a 90 degree angle from the sample, resulting in accurate and repeatable measurements. Additionally, the internal housing for the cuvette is opaque, which limits ambient light interference to preserve accuracy.

Features:

- ▶ Stabilized light source for consistent readings
- ▶ Measures six different wavelengths simultaneously
- ▶ PASCO software displays the absorbance & transmittance at each wavelength in the appropriate color
- ▶ Quick and easy calibration
- ▶ Wireless design enables data collection in the field
- ▶ Pre-calibrated for ezSample Snap Vial Kits

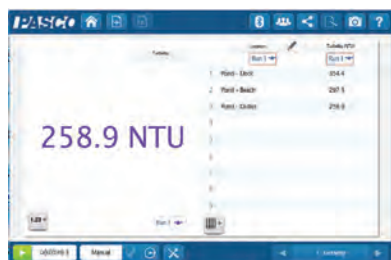

Measure the absorbance and transmittance of a solution at six different wavelengths... simultaneously!



WARNING! This product can expose you to chemicals including Formaldehyde, which is known to the State of California to cause cancer. For more information go to www.P65Warnings.ca.gov.

Order Information

Wireless Colorimeter & Turbidity SensorPS-3215
Includes USB Charging cable, 9 cuvettes, 2 cuvette racks, and one 100 NTU calibration cuvette.

Chemical Water Quality Testing in the Field

PASCO's ezSample water quality test kits simplify the chemical testing of water sources. Avoid the mess and difficulty of handling chemicals directly and get great results, even in the field.

Colorimetric Analysis

Conduct colorimetric tests in the field and avoid the mess and tedium of mixing chemicals. These ezSample Snap Vials contain a pre-formulated reagent to test a variety of water quality parameters. No more guessing at color variations—drop the vial into the Water Quality Colorimeter and read the concentration.



Order Information

- ezSample Snap Vial - IronEZ-2331
- ezSample Snap Vial - Nitrate.....EZ-2333B
- ezSample Snap Vial - AmmoniaEZ-2334A
- ezSample Snap Vial - Phosphate.....EZ-2337
- ezSample Snap Vial - ChlorineEZ-2339A
- ezSample Field Titrator - Total HardnessEZ-2338
- ezSample Field Titrator - AlkalinityEZ-2340

WARNING! This product can expose you to chemicals including phenolphthalein, which is known to the State of California to cause cancer, and methanol, which is known to the State of California to cause birth defects or other reproductive harm. For more information go to www.P65Warnings.ca.gov.

WARNING! This product can expose you to chemicals including ethylene glycol, which is known to the State of California to cause birth defects or other reproductive harm. For more information go to www.P65Warnings.ca.gov.

PASPORT Salinity Sensor

PS-2195

The PASPORT Salinity Sensor works with the 10X Salinity Sensor Probe to measure the salinity, conductivity, and temperature of fresh to brackish water sources. The sensor determines salinity based on electrical conductivity. It also features a built-in calculation, based on the Practical Salinity Scale (PSS), that compensates for changes in conductivity caused by temperature changes.



Order Information

PASPORT Salinity SensorPS-2195

PASPORT Flow Rate/Temperature Sensor

PS-2130

PASCO's Flow Rate Sensor allows students to measure the rate of movement and temperature of streams, rivers, and other flowing systems. The propeller is a rugged, single-piece unit encased by protective material — no more losing pieces at the bottom of the stream.



Order Information

PASPORT Flow Rate/Temperature Sensor.....PS-2130

Advanced Water Quality Sensor

PS-2230

The Advanced Water Quality Sensor provides unparalleled capabilities for an exceptional price. It can be used to measure Dissolved Oxygen, Temperature, Conductivity, and pH both individually and simultaneously. With its included optical dissolved oxygen probe and built-in barometric pressure sensor, this multipurpose sensor is a turn-key solution for obtaining accurate water quality data.



Order Information

Advanced Water Quality SensorPS-2230

PASPORT Non-Contact Temperature Sensor

PS-2197

The Non-Contact Temperature Sensor measures surface temperature by detecting the emitted infrared light. Record the temperature of objects without touching them!



Order Information

PASPORT Non-Contact Temperature SensorPS-2197

Go Wireless with PASPORT Sensors

PASCO's AirLink Interface connects PASPORT (blue or black) sensors to your computer using Bluetooth or USB technology.



AirLink Interface



PS-3200

The Airlink connects PASPORT sensors to a Mac or Windows computer, Chromebook, iPad, tablet, or smartphone via Bluetooth or USB connection. The USB cable is included.



Order Information

AirLink InterfacePS-3200



PASCO's Integrated Solutions for Physics

PASCO provides High School Physics educators with the most groundbreaking solutions on the market. Our solutions incorporate wireless, cross-platform technology with inquiry-based, hands-on activities to foster active learning. Using our award-winning data collection and analysis software, sensors, and curriculum, you can easily explore topics such as Mechanics; Electricity and Magnetism; Optics; Thermodynamics; Oscillations, Waves, and Sound; and much more. Whether you teach Honors, IB[®], AP[®] Physics 1 or 2, or General Physics courses, we offer lab manuals, experiments, and textbooks for your curricular needs.

Physics Index

Physics Lab Stations	79
Advanced Physics 1	80
Advanced Physics 2	82
Essential Physics Curriculum	84
Essential Physics Lab Manual & Equipment	86
Modular Circuits	88
MatchGraph Free Motion Graphing Software	90
Wireless Smart Cart	91
Smart Cart Demo Kit and Accessories	92
Wireless Rotary Motion Sensor.....	94
Wireless Smart Gate and Launchers	95
Wireless Sensors for Physics.....	96
New Wireless Geiger Counter.....	99
New Wireless Force Platforms.....	101
SPARK LXi2 & the 550 Universal Interface.....	102
Interface Comparison	103
PASCO Capstone.....	104

See the amazing Smart Cart Demo Kit!

For information about this and PASCO's other Physics investigation kits see page 92.



Are you receiving our Physics Catalog? It includes our full line of Physics equipment!

Go to pasco.com/catalogs



Physics Lab Stations

EP-3579/EP-3580

The Physics Starter Lab Station makes it easy and affordable to begin using sensor-based technology in your physics lab or classroom. Inside the Starter Lab Station are the wireless sensors used to perform 9 kinematics, dynamics, voltage, and circuit lab activities from the Physics Lab Station Investigations Manual. Available separately is the Physics Extension Lab Station (EP-3580) which, when combined with the Physics Starter Lab Station, comprises all the wireless sensors used to perform the 20 labs inside the Physics Lab Station Investigations Manual, plus many of the lab activities found in PASCO's Advanced Physics 1 and Advanced Physics 2 Lab Manuals.



Physics Station Lab Titles

Included with the Starter Lab Station are 10 printed labs from the 21 labs inside the digital Physics Lab Station Investigations Manual.

1. Position, Distance and Displacement
2. Newton's 2nd Law
3. Crash Cushions
4. Momentum and Impulse

5. Change in Kinetic Energy
6. Rotational Dynamics
7. Measuring the Speed of Sound - Echo
8. Ohm's Law
9. DC Circuits
10. RC Circuits

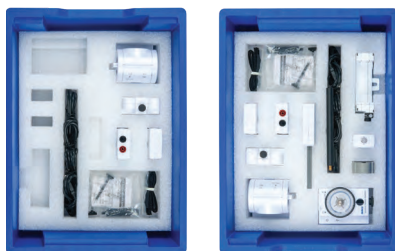

Shown here: Physics Starter & Extension Lab Stations

The Physics Starter & Extension Lab Stations include a lab manual as well as these wireless sensors and materials:

Starter

- ▶ Motion
- ▶ Current
- ▶ Voltage
- ▶ Force
- ▶ Storage Case

Extension

- ▶ 3-Axis Acceleration/ Altimeter
- ▶ 3-Axis Magnetic Field
- ▶ Rotary Motion
- ▶ Smart Gate
- ▶ Sound

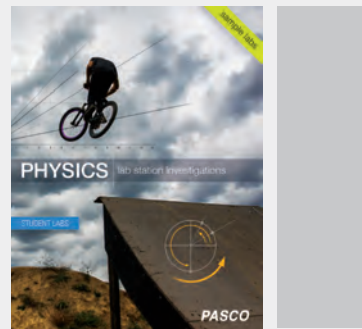

Essential Physics Lab Station Investigations

The Physics Lab Station Investigations Manual includes the following student investigations. Visit the PASCO Experiment Library online to preview and download student lab investigations and materials lists for free.

- Position, Distance, and Displacement
- Newton's Second Law
- Modeling the Force of Friction
- Designing and Testing Crash Cushions
- Impulse and Change in Velocity
- Change in Kinetic Energy
- Atwood's Machine
- Angular Velocity and Centripetal Acceleration
- Rotational Dynamics
- Rotational Collisions
- Simple Pendulum
- Properties of Sound Waves
- Measuring the Speed of Sound with an Echo
- Decoding DTMF Tones
- Magnetic Field Strength
- Magnetic Field of a Permanent Magnet
- Ohm's Law
- DC Circuits
- Capacitors and RC Circuits
- Fruit Battery
- Blockly Extension: Acoustic Stopwatch

Order Information

- Physics Starter Lab StationEP-3579
 Physics Extension Lab Station.....EP-3580

Advanced Physics 1 Lab Manual

This experiment guide covers the latest standards for College Board Advanced Placement Physics 1.

- ▶ Every lab is based on the College Board Learning Objectives.
- ▶ Data Analysis and Assessment Questions are designed to prepare students for the AP[®] Physics 1 exam.
- ▶ Every lab employs the same strategies found in free response questions on the AP[®] exam.
- ▶ Includes editable student handouts.

Prepare your students for inquiry investigations in the physics lab. Each lab is presented three ways:

- ▶ Structured
- ▶ Guided inquiry
- ▶ Student designed

You decide which level of inquiry is appropriate for each lab.

Each lab includes teacher resources:

- ▶ Pre-lab discussion and questions
- ▶ Sample data
- ▶ Procedural overview
- ▶ Assessment and synthesis questions
- ▶ Teacher tips
- ▶ Extended inquiry suggestions

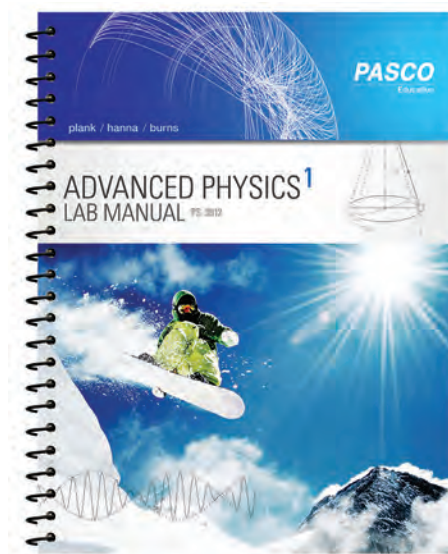

ADV PHYSICS 1 EXPERIMENTS	EQUIPMENT		ALIGNMENT	
	LAB	Perform these labs with the PS-3813 Equipment Kit	Add the PS-3814 Expansion Kit to perform all these labs	IB [®] Standards*
1. Graphical Analysis: Motion	✓	✓	2.1	3.A.1.1, 2, 3
2. Newton's Second Law	✓	✓	2.2	3.B.1.1, 2, 3, 3.B.2.1
3. Atwood's Machine	✓	✓	2.2	3.B.1.1, 2
4. Coefficients of Friction	✓	✓	2.2	3.C.4.1,2
5. Two Dimensional Motion: Projectiles		✓	1.3, 2.1	3.E.1.3, 4
6. Conservation of Mechanical Energy	✓	✓	2.3	5.B.4.1,2
7. Work and Kinetic Energy	✓	✓	2.3	4.C.2.1, 2
8. Conservation of Momentum		✓	2.4	5.D.1.3,5.D.2.2, 4
9. Momentum and Impulse	✓	✓	2.4	3.D.2.3, 4
10. Rotational Dynamics		✓	B.1	3.F.2.1, 2, 3.A.1.3
11. Rotational Statics		✓	B.1	3.F.1.1, 2, 3, 4, 5
12. Periodic Motion: Mass and Spring	✓	✓	4.1, 9.1	3.B.3.1, 2, 3, 4
13. Simple Pendulum	✓	✓	4.1, 9.1	3.B.3.1, 2, 3
14. Resonance and Standing Waves		✓	4.5, B.4	6.D.3.4, 6.D.4.1, 2
15. DC Circuits		✓	5.1, 5.2	1.B.1.2, 5.B.9.2, 3, 5.C.3.1

Each experiment guide includes video support

How-to videos are included with the manual, on the PASCO website and on YouTube, and can be installed on your own computers.



Try It!



* IB is a registered trademark of the International Baccalaureate Organization, which was not involved in the production of, and does not endorse, this product.
 ** AP is a trademark registered and/or owned by the College Board, which was not involved in the production of, and does not endorse, this product.

Advanced Physics 1 Equipment Kit

Equipment	Part #	Qty			
Smart Cart (red)	ME-1240	1	250-g Cart Mass (set of 2)	ME-6757A	3
PAStrack	ME-6960	1	Discover Friction Accessory Tray	ME-8574	1
Dynamics Track End Stop (2 pack)	ME-8971	1	45-cm Stainless Steel Rod	ME-8736	1
Four Scale Meter Stick	SE-8695	1	Angle Indicator	ME-9495A	1
250-g Compact Cart Mass	ME-6755	2	Dynamics Track Rod Clamp	ME-9836	1
Mass & Hanger Set	ME-8979	1	Bumper Accessory Set	ME-9884	1
Super Pulley Kit	ME-9433	1	Smart Cart Rod Stand Adapter	ME-1244	1
Thread	ME-9875	1	90-cm Stainless Steel Rod	ME-8738	1
60-cm Stainless Steel Rod	ME-8977	1	Demonstration Spring Set	ME-9866	1
Aluminum Table Clamp	ME-8995	1	Hooked Mass Set	SE-8759	1
Wireless Smart Gate	PS-3225	1	Photogate Pendulum Set	ME-8752	1
Right Angle Clamp	SE-9444	1	Pendulum Clamp	ME-9506	1



Advanced Physics 1 Expansion Kit

Equipment	Part #	Qty			
Smart Cart (blue)	ME-1241	1	Tuning Fork Set	SE-7342	1
Pendulum Accessory	ME-8969	1	Resonance Air Column	WA-9606	1
Aluminum Table Clamp	ME-8995	1	AC/DC Electronics Lab Kit	EM-8656	1
Wireless Rotary Motion Sensor	PS-3220	1	Wireless Voltage Sensor	PS-3211	1
Stainless Steel Calipers	SF-8711	1	Wireless Current Sensor	PS-3212	1
Tension Protractor	ME-6855	2	Photogate Mounting Bracket	ME-6821A	1
60-cm Stainless Steel Rod	ME-8977	1	Mini Launcher	ME-6825B	1
Aluminum Table Clamp	ME-8995	1	Carbon Paper	SE-8693	1

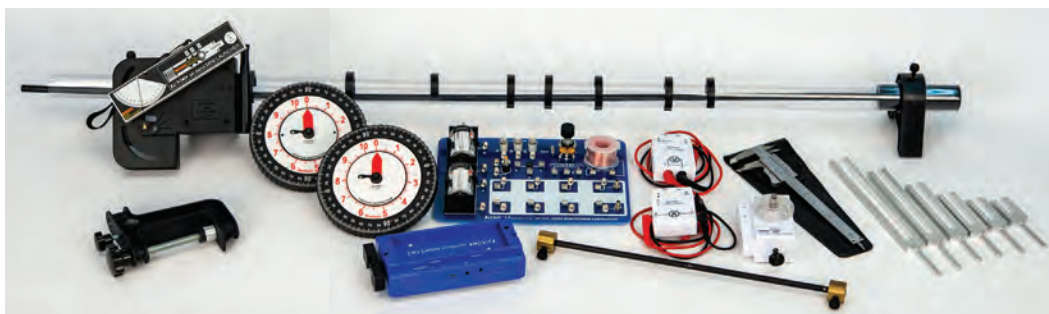

Advanced Physics Sensor Bundle

Equipment	Part #	Qty
1. Smart Cart (red)	ME-1240	1
2. Wireless Smart Gate	PS-3225	1
3. Smart Cart (blue)	ME-1241	1
4. Wireless Rotary Motion Sensor	PS-3220	1
5. Wireless Voltage Sensor	PS-3211	1
6. Wireless Current Sensor	PS-3212	1
7. Wireless Pressure Sensor	PS-3203	1
8. Wireless Magnetic Field Sensor	PS-3221	1

Just need sensors?

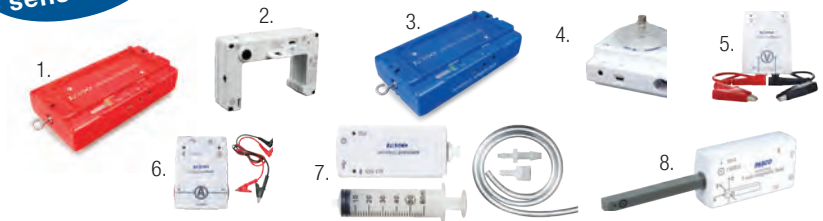

Order Information

Advanced Physics 1 Equipment Kit	PS-3813	Advanced Physics 1 Lab Manual	PS-3812
Advanced Physics 1 Expansion Kit	PS-3814		
Advanced Physics Sensor Bundle	PS-3818		

Advanced Physics 2 Lab Manual

This experiment guide covers the latest standards for College Board Advanced Placement Physics 2.

- ▶ Every lab is based on the College Board Learning Objectives.
- ▶ Data Analysis and Assessment Questions are designed to prepare students for the AP[®] Physics 2 exam.
- ▶ Every lab employs the same strategies found in free response questions on the AP[®] exam.
- ▶ Includes editable student handouts.

Prepare your students for inquiry investigations in the physics lab. Each lab is presented three ways:

- ▶ Structured
- ▶ Guided inquiry
- ▶ Student designed

You decide which level of inquiry is appropriate for each lab.

Each lab includes teacher resources:

- ▶ Pre-lab discussion and questions
- ▶ Sample data
- ▶ Procedural overview
- ▶ Assessment and synthesis questions
- ▶ Teacher tips
- ▶ Extended inquiry suggestions

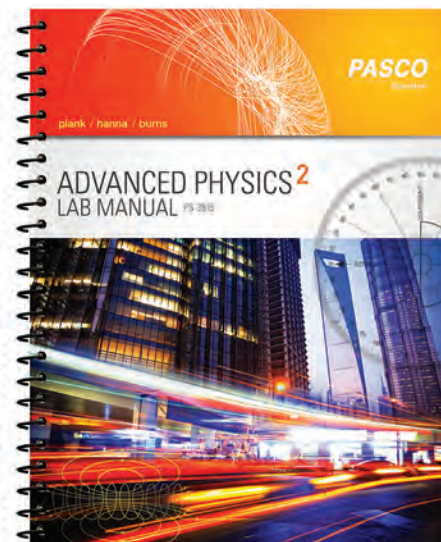

ADV PHYSICS 2 EXPERIMENTS	EQUIPMENT		ALIGNMENT	
	LAB	Perform these labs with the PS-3816 Equipment Kit	Add the PS-3817 Expansion Kit to perform all these labs	IB [®] Standards*
1. Hydrostatic Pressure	✓	✓	B.3	3.C.4.1, 3.C.4.2
2. Buoyant Force		✓	B.3	1.E.1.2, 3.A.3.1, 3.C.4.2
3. Fluid Dynamics	✓	✓	B.3	5.B.10.1, 5.B.10.3, 5.B.10.4
4. Boyle's Law	✓	✓	3.2	5.B.7.2, 7.A.3.2, 7.A.3.3
5. Spherical Mirror Reflection	✓	✓	C.1	6.E.4.1, 6.E.4.2
6. Snell's Law	✓	✓	4.4	6.E.3.2, 6.E.3.3
7. Focal Length of a Converging Lens	✓	✓	C.1	6.E.5.1, 6.E.5.2
8. Interference and Diffraction	✓	✓	4.4, 9.2, 9.3	6.C.3.1
9. Electric Field Mapping		✓	5.1, 10.1	2.E.2.1
10. Magnetic Fields		✓	5.4	2.D.2.1, 2.D.3.1, 2.D.4.1
11. Magnetic Field Strength		✓	5.4	2.D.2.1
12. Electromagnetic Induction	✓	✓	11.1	4.E.2.1
13. Capacitor Fundamentals		✓	11.3	4.E.4.2, 4.E.4.3
14. Series and Parallel Capacitors		✓	11.3	4.E.5.3, 5.B.9.5
15. RC Circuits		✓	11.3	4.E.5.1, 4.E.5.2, 4.E.5.3
16. Planck's Constant		✓	12.1	6.F.3.1, 6.F.4.1

Each experiment guide includes video support!

How-to videos are included with the manual, on the PASCO website and on YouTube, and can be installed on your own computers.



Try It!



* IB is a registered trademark of the International Baccalaureate Organization, which was not involved in the production of, and does not endorse, this product.
 ** AP is a trademark registered and/or owned by the College Board, which was not involved in the production of, and does not endorse, this product.

Advanced Physics 2 Equipment Kit

Equipment	Part #	Qty
Water Reservoir	ME-8594	1
Wireless Pressure Sensor	PS-3203	1
Four-Scale Meter Stick	SE-8695	1
Concave Mirror Accessory	OS-8457	1
Basic Optics Light Source	OS-8470	1
Optics Track, 1.2 m	OS-8508	1
Basic Optics Ray Table	OS-8465	1
Basic Optics Viewing Screen	OS-8460	1
Converging Lens, 50-mm diam.	OS-8466A	1
Adjustable Lens Holder	OS-8474	1
Diffraction Plate	OS-8850	1
Rod, 45-cm	ME-8736	2
Aluminum Table Clamp	ME-8995	2
Stainless Steel Calipers	SE-8710	1
Three-finger Clamp	SE-9445	2
Laser Pointer (with known wavelength)	SE-9716B/C	1
Wireless Voltage Sensor	PS-3211	1
Not Pictured: .539 ID Plastic Tube, 12"		1
Magnet or Enameled Wire, 22-gauge		1



Advanced Physics 2 Expansion Kit

Equipment	Part #	Qty	Equipment	Part #	Qty
Smart Cart (red)	ME-1240	1	Digital Multimeter	SE-9786A	1
Aluminum Table Clamp	ME-8995	1	Neodymium Magnets, solid (16 pack)	EM-8648B	1
Thread	ME-9875	1	AC/DC Electronics Lab Kit	EM-8656	1
Overflow Can	SE-8568	1	Magnaprobe™ Wand	SE-7390	1
Right Angle Clamp	SE-9444	1	4-mm Banana Plug Patch Cord (5 pack)	SE-9750	2
Field Mapper Kit	PK-9023	1	Wireless 3-Axis Magnetic Field Sensor	PS-3221	1
Student Power Supply, 18 VDC, 3 A	SE-8828	1	Wireless Current Sensor	PS-3212	1



Not Pictured:	Qty
Aluminum Cylinder	1
Brass Cylinder	1
Magnet or Enameled Wire, 22-gauge	1
Capacitor, 100- μ F	5
Blue LED (450–500 nm)	1
Green LED (501–565 nm)	1
Yellow/Amber LED (566–620 nm)	1
Red LED (621–750 nm)	1

Advanced Physics Sensor Bundle

Equipment	Part #	Qty
1. Smart Cart (red)	ME-1240	1
2. Wireless Smart Gate	PS-3225	1
3. Smart Cart (blue)	ME-1241	1
4. Wireless Rotary Motion Sensor	PS-3220	1
5. Wireless Voltage Sensor	PS-3211	1
6. Wireless Current Sensor	PS-3212	1
7. Wireless Pressure Sensor	PS-3203	1
8. Wireless Magnetic Field Sensor	PS-3221	1

Just need sensors?



Order Information

Advanced Physics 2 Equipment Kit	PS-3816
Advanced Physics 2 Expansion Kit	PS-3817
Advanced Physics Sensor Bundle.....	PS-3818

Advanced Physics 2 Lab Manual.....PS-3815

Essential Physics - Your COMPLETE Physics Solution



PASCO's Essential Physics is the only curriculum solution that includes a Student Textbook, Student e-Book, Teacher e-Resources, Student Lab Manual, and Equipment Kits, all at a very affordable price. This 3-D STEM program includes a full year of instruction for both General and Honors Physics classes.

Student Textbook & Lab Investigations

- ▶ 27 chapters cover a full year of instruction for High School General and Honors Physics programs
- ▶ One main idea per page
- ▶ Quality illustrations
- ▶ Section and Chapter reviews
- ▶ 82 complete investigations
- ▶ 8 Engineering Design Projects

Student e-Book

- ▶ Browser-based version of the textbook
- ▶ Same layout with convenient 24/7 online access
- ▶ Embedded videos and animations bring content to life
- ▶ Interactive equations and simulations enrich key concepts
- ▶ Formative and summative assessment questions

Teacher e-Resources for Lab Manual

- ▶ SPARKvue software
- ▶ Editable documents
- ▶ PowerPoint presentations
- ▶ Answer keys
- ▶ Video lab assistance

Teacher e-Resources for Textbook

- ▶ Infinite Test Bank
- ▶ Teacher User Guide
- ▶ Teacher e-Book (1-year or multi-year license)

Use our complete solution or integrate Essential Physics into your existing curriculum. Essential Physics is multiplatform and works on iOS, Android™, Chrome™, Windows®, and Mac®. What's more, it includes 24/7 online access, as well as correlations to NGSS and your state standards.

Teacher e-Resources for Textbook

- ▶ Infinite Test Bank
- ▶ Teacher User Guide
- ▶ Teacher e-Book (1-year or multi-year license)
- ▶ Alignment details for NGSS and state standards

PASCO Academy Physics Resources

- ▶ Available through your PASCO Educator account
- ▶ 25 engaging video labs with detailed instruction and data collection
- ▶ 25 datasets for student analysis and discussion
- ▶ 25 editable lab handouts with teacher answer keys
- ▶ Digital access to more than 80 labs for General and Honors Physics

Equipment

- ▶ Comprehensive Equipment Kit supports the textbook and lab investigations
- ▶ **Comprehensive Equipment Kit includes these individual kits:** Forces and Motion; Oscillations, Waves, and Sound; Simple Machines Engineering; Modular Circuits; Light, Color, and Optics; and more
- ▶ Standard Equipment Kit includes Forces and Motion Kit and Modular Circuits Kit

Essential Physics correlates with NGSS and is constructed around the three dimensions:

- ▶ Science and Engineering Practices
- ▶ Crosscutting Concepts
- ▶ Disciplinary Core Ideas



Textbook + e-Book + Equipment

Essential Physics Student Textbook

EP-6323

This rigorous yet accessible textbook includes core Physics topics that cover a complete year of instruction for both High School General and Honors Physics classes. The lessons follow the 5E model and include tools for ELL students, as well as tools for students with different learning styles. And the curriculum aligns to NGSS and your state standards for both regular and advanced coursework. The accessible textbook includes one main idea per page, quality illustrations, 89 complete investigations, eight Design Projects, and Section and Chapter Reviews. The 27 chapters cover these topics:

- ▶ Science of Physics
- ▶ Physical Quantities and Measurement
- ▶ Position and Velocity
- ▶ Acceleration
- ▶ Forces and Newton's Laws
- ▶ Motion in Two and Three Dimensions
- ▶ Circular Motion
- ▶ Static Equilibrium and Torque
- ▶ Work and Energy
- ▶ Conservation of Energy
- ▶ Momentum and Collisions
- ▶ Machines
- ▶ Angular Momentum
- ▶ Harmonic Motion
- ▶ Sound Waves
- ▶ Electricity and Circuits
- ▶ Electric and Magnetic Fields
- ▶ Electromagnetism
- ▶ Light and Reflection
- ▶ Refraction and Lenses
- ▶ Electromagnetic Radiation
- ▶ Properties of Matter
- ▶ Heat Transfer
- ▶ Thermodynamics
- ▶ Quantum Physics and the Atom
- ▶ Nuclear Physics

Essential Physics Student e-Book

The Student e-Book is an electronic version of the full textbook with interactive elements. Throughout the electronic text, content and theory are supported with optional audio reading, as well as interactive elements, such as digital equations, videos, animations, and simulations. Students also have the option of expanding the content using the 'more' button to go deeper into concepts.

Essential Physics Student Lab Manual

EP-6326

The *Essential Physics Student Lab Manual* is a student-consumable print book. In the manual there are 46 of the 89 labs (from the *Essential Physics 3* textbook) that cover a full year of instruction. Best of all, the labs are completely integrated with PASCO equipment and software.

Comprehensive Physics Equipment Kit

EP-6490

This kit is designed to support the lab investigations in the Essential Physics 3rd Edition curriculum. When used as part of our Essential Physics program, including the e-Book and lab manual, it creates a complete solution for teaching high school Physics. It can also be used to supplement your existing textbook, serving as the lab component of your curriculum. This use is supported by the more than 46 standards-based Essential Physics labs, representing a full year of investigations for a standard physics course. Inside this comprehensive kit are the following:

- ▶ Forces and Motion Kit
- ▶ Simple Machines Engineering Kit
- ▶ Oscillations, Waves, and Sound Kit
- ▶ Light, Color, and Optics Kit
- ▶ Essential Physics Modular Circuits Kit
- ▶ Projectile Launcher
- ▶ Additional Red Smart Cart

Also available:

Standard Physics Equipment Kit

EP-3567

- ▶ Forces and Motion Kit
- ▶ Modular Circuits Kit



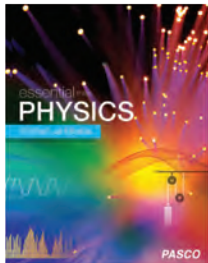

Essential Physics Student Lab Manual

EP-6326

The *Essential Physics* Student Lab Manual is a student-consumable print book. In the manual there are 46 labs that cover a full year of instruction. Best of all, the labs are completely integrated with PASCO equipment and software.

Investigations and activities in the student lab manual cover topics such as:

- Graphs of Motion
- Motion Graphs
- Acceleration
- A Model for Accelerated Motion
- Newton's Second Law
- Hooke's Law
- Static and Kinetic Friction
- Projectile Motion
- Acceleration on an Inclined Plane
- Static Equilibrium
- Work and the Force vs. Distance Graph
- Inclined Plane and the Conservation of Energy
- Work and Energy
- Springs and the Conservation of Energy
- Work Done by Friction
- Design a Crash Barrier
- Conservation of Momentum
- Inelastic Collisions
- Elastic Collisions
- Levers
- Pulleys
- Ramps and Inclined Planes
- Gear Ratios
- Designing Gear Machines
- Torque
- Mechanical Advantage of Gears
- Oscillators
- Resonance
- Waves
- Interference
- Resonance and Sound
- Design a Musical Instrument
- Electricity and Circuits
- Voltage and Batteries
- Design a Lemon Battery
- Resistors and Ohm's Law
- Series and Parallel Resistances
- Electrical Power
- Compound Circuits
- Magnification of Mirrors and Lenses
- Reflection in a Plane Mirror
- Refraction of Light
- Creating Real and Virtual Images with Lenses
- Image Formation for a Convex Lens
- Build a Microscope and Telescope
- Phosphorescence

Comprehensive Equipment Kit *46 labs are designed to use this equipment set.*

- Forces & Motion Kit
- Simple Machines Engineering Kit
- Oscillations, Waves & Sound Kit
- Light, Color & Optics Kit
- Essential Physics Modular Circuits Kit
- Additional Red Smart Cart
- Mini Launcher, Clamp & Rod
- One 1.2 m Metal Dynamics Track
- Two Tripod Stands

Each kit includes a Gratnells® Storage Tray.



Standard Equipment Kit *25 labs are designed to use this equipment set.*

- Smart Cart (Blue), ME-1241
- Friction Block, ME-9807
- PAScar Cart Mass (set of 2), ME-6757A
- Angle Indicator, ME-9495A
- Track End Stop (set of 2), ME-8971
- Super Pulley with Clamp, ME-9448B
- 1.2 m Dynamics Track, ME-9493
- Track Feet (set of 2), ME-8972
- Weights
- Modular Circuits
- Wireless Current Module
- Wireless Voltage Sensor
- Gratnells® Storage Tray



Order Information

Essential Physics Teacher Lab ManualEP-6329
 Essential Physics Student Lab ManualEP-6326

Essential Physics Comprehensive Equipment Kit..EP-6490A
 Essential Physics Standard Equipment Kit.....EP-3567A

Essential Physics Kits

Choose the kit you need for your investigations.



EP-3558

Light, Color & Optics Kit

Sample Labs

- Magnification of Mirrors and Lenses
- Reflection in a Plane Mirror
- Refraction of Light
- Creating Real and Virtual Images with Lenses
- Image Formation for a Convex Lens
- Build a Microscope and Telescope



EP-3577

Simple Machines Engineering Kit

Sample Labs

- Static Equilibrium
- Levers
- Pulleys
- Gear Ratios
- Designing Gear Machines
- Torque
- Mechanical Advantage of Gears



EM-3536

Essential Physics Modular Circuits Kit

Sample Labs

- Electricity and Circuits
- Voltage and Batteries
- Design a Lemon Battery
- Resistors and Ohm's Law
- Series and Parallel Resistances
- Electrical Power
- Compound Circuits



EP-3578

Oscillations, Waves & Sound Kit

Sample Labs

- Oscillators
- Resonance
- Waves
- Interference
- Resonance and Sound
- Design a Musical Instrument



EP-3576

Forces & Motion Kit

Sample Labs

- Graphs of Motion
- Motion Graphs
- Acceleration
- A Model for Accelerated Motion
- Newton's Second Law
- Hooke's Law
- Static and Kinetic Friction
- Acceleration on an Inclined Plane
- Conservation of Momentum

Go to pasco.com and enter the kit part number for complete kit contents



THE AMAZING SMART CART DEMO KIT!!

Smart Cart Demo Kit Includes: Wireless Smart Cart (red or blue), Smart Fan Accessory, Smart Cart Vector Display, Smart Ballistic Cart Accessory, Rod Adapter, Hook, Cart Mass (2), Magnetic Bumper, Sail, Demonstration Manual, and storage case.

Demos Include: Differences Between Velocity and Acceleration, Independence of x and y Projectile Motion, Newton's First Law, Newton's Second Law, Newton's Third Law, Impulse and Force, Collisions, Centripetal Acceleration, Simple Harmonic Motion, and Buoyant Force.

Demos are key to Physics instruction! The Smart Cart Demo Kit contains everything you need to demo Kinematics, Dynamics & more!



Order Information

Light, Color & Optics KitEP-3558
 Simple Machines Engineering KitEP-3577
 Essential Physics Modular Circuits KitEM-3536
 Oscillations, Waves & Sound KitEP-3578

Forces and Motion KitEP-3576
 Red Smart Cart Demonstration KitME-1272
 Blue Smart Cart Demonstration KitME-1273

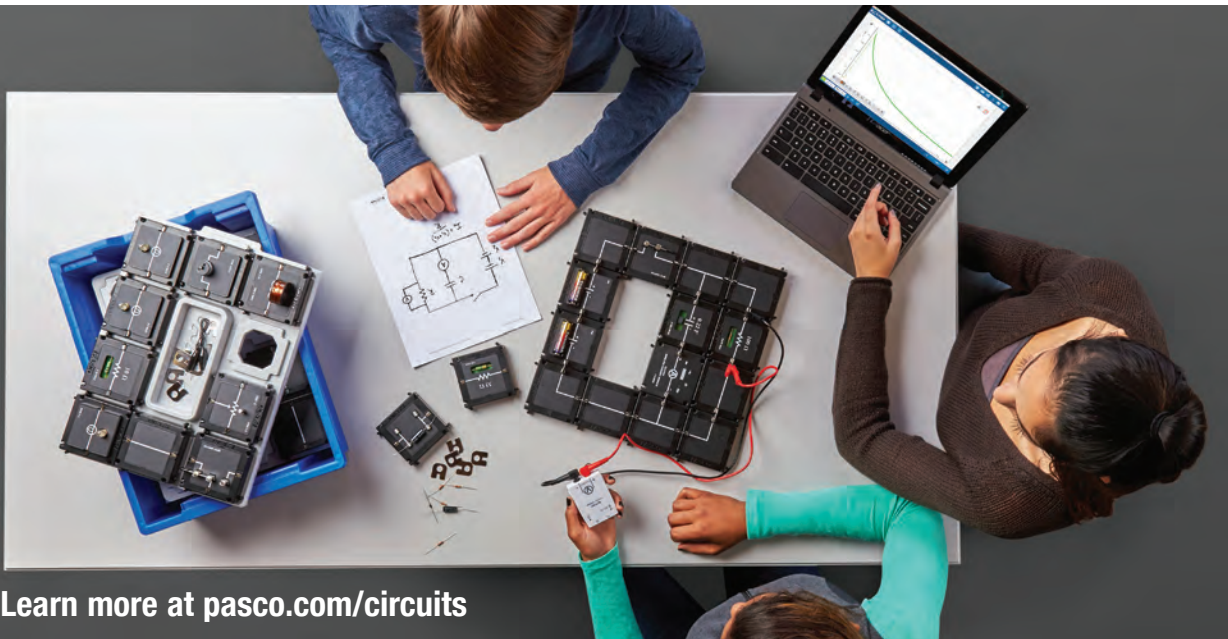

Learn more at pasco.com/circuits

Basic Modular Circuits Kit

EM-3535

These circuit modules are designed specifically for introductory circuit investigations. For students who have never wired a circuit, this modular system makes it easy for them to see their circuit physically laid-out exactly as it appears in their circuit diagram.

Each module connects mechanically to another by sliding the tabs into each other. It works on any tabletop. No special surface is required. To electrically connect two modules, students insert a jumper clip, which emphasizes that an electrical connection has been made. The large size of the modules (8 cm x 8 cm) enables all the students around the table to see and understand the completed circuit.

Each module connects mechanically to another by sliding the tabs into each other. To make them visible, many of the components are mounted on top of the module or in a well for protection.



The Basic Modular Circuits Kit is a lower cost, introductory set with fewer components than the Essential Physics Modular Circuits Kit. The Wireless Voltage Sensor and Wireless Current Module are not included.



Order Information

Basic Modular Circuits Kit.....EM-3535

Essential Physics Modular Circuits Kit

EM-3536

The Essential Physics Modular Circuits Kit includes more modules, such as the Wireless Current Sensor Module and Wireless Voltage Sensor. The Essential Physics Modular Circuits Kit will also support applications like RC and RLC circuit analysis, electric motors, Kirchhoff's Laws, and much more!

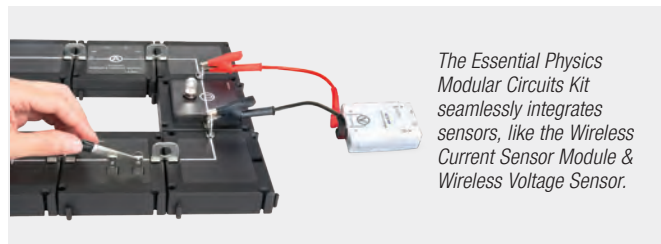

The Essential Physics Modular Circuits Kit seamlessly integrates sensors, like the Wireless Current Sensor Module & Wireless Voltage Sensor.



Order Information

Essential Physics Modular Circuits Kit.....EM-3536

Modular Circuits Expansion Kit.....EM-3540

Choose from 3 Modular Circuit Kits

Kits include these modules and apparatus:

	Basic EM-3535	Essential EM-3536	Expansion EM-3540		Basic EM-3535	Essential EM-3536	Expansion EM-3540
Corner Wire	4	4	2	Battery, AA	2	2	
Straight Wire	4	5	2	Jumper Clips	30	45	15
Tee	2	2	2	Diode	1	1	
Spring	1	1	1	330 ohm Resistor	1	2	
Switch, SPDT	1	1		1000 ohm Resistor	1	2	
Switch, SPST	1	1		100 microfarad Capacitor	1	1	
Resistor	2	3		330 microfarad Capacitor	1	1	
Capacitor	1	1		Magnets (0.45" x 0.25")	0	8	
Light Bulb	2	3	1	Plotting Compass	0	1	
Potentiometer	0	1		Alligator Clip Jumper Wire	0	1	
Motor	0	1		EM-3534 Wireless Current Sensor	0	1	
LED	0	1		PS-3211 Wireless Voltage Sensor	0	1	
1000 Turn Coil	0	1		Gratnells® Storage Tray	1	1	1
Battery Holder	2	2	1	Banana Jack Terminal			1

Wireless AC/DC Module

EM-3533

The Wireless AC/DC Module is a Bluetooth Low Energy wireless signal generator designed for use with PASCO's Modular Circuits. The AC/DC Module can act as a DC power supply, as well as generate Sine, Triangle, and Square AC signals. A built-in battery provides long lasting power for your basic circuits, and it can be recharged using the included USB cable. An internal voltage sensor monitors the output voltage at all times. The Wireless AC/DC Module is controllable in either PASCO Capstone or SPARKvue software. This latest circuit module expands the number and type of experiments you can perform with Modular Circuits including Ohm's Law, RC Circuit Time Constant, and LRC labs.

Programmable using Blockly programming in PASCO Capstone 2 and SPARKvue software.

Features:

- ▶ Compatible with Modular Circuits
- ▶ ± 3 V Output; 0.3 A Max
- ▶ DC, Sine, Triangle, Square
- ▶ Bluetooth Low Energy
- ▶ Rechargeable Battery
- ▶ Controllable with PASCO Capstone or SPARKvue Software



Perform Circuits Emulations with Modular Circuits and PASCO Capstone 2

Reinforce circuit concepts and tackle student misconceptions using circuit visualization.

When you use Modular Circuits with PASCO Capstone 2 and its Circuits Emulation tool, you can:

- ▶ Construct and modify circuits
- ▶ Show conventional current or electron flow animation
- ▶ Animate circuits with live sensor data

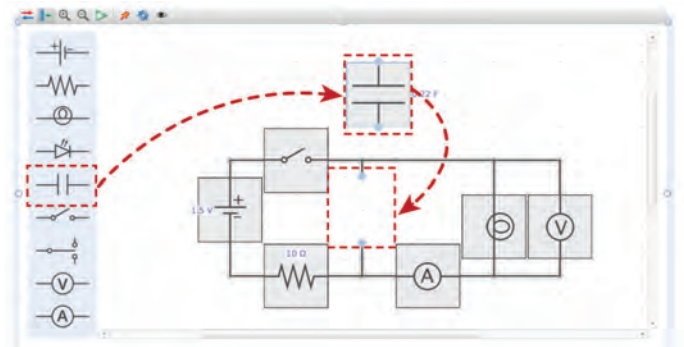

Order Information

Wireless AC/DC ModuleEM-3533

Learn more about Capstone 2 on pages 104-107.



Wireless Motion Sensor

PS-3219

The Wireless Motion Sensor connects via Bluetooth or USB to your device, and uses ultrasound to measure the position, velocity, and acceleration of objects. This enables students to take turns measuring themselves, while the class observes their motion materializing as a graph in real time. The sensor can detect objects ranging from 15 cm to 4.0 m away, and without cables to get in the way, students can explore handheld and ceiling-mounted applications.

Features:

- ▶ Measures position, velocity, and acceleration
- ▶ False Target Rejection Technology produces clean data
- ▶ Clips directly to PASCO Dynamics Tracks
- ▶ Rod clamp for mounting
- ▶ 180° pivoting head
- ▶ Rechargeable lithium-ion battery
- ▶ Bluetooth® and USB connectivity



Order Information

Wireless Motion SensorPS-3219

Free MatchGraph! Software

MatchGraph software is the most intuitive way to teach motion graphing. Engage your students with a kinesthetic experience that teaches graphing centered on motion. In MatchGraph, students attempt to match one of the nine provided graphs and are given a score showing how accurately they match the chosen curve. This activity gives them a deeper understanding of interpreting graphs as they see their own position and velocity graphed in real time.

Using a PASCO Motion Sensor, students create graphs of their own motion that they can then analyze. When using a Smart Cart, a real-time motion graph is displayed as students move the cart.

MatchGraph is great for teaching:

- ▶ Fundamental graphing skills
- ▶ Basic concepts of position and velocity
- ▶ The concept of slope
- ▶ What it means when the slope is zero
- ▶ How position and velocity graphs relate to each other

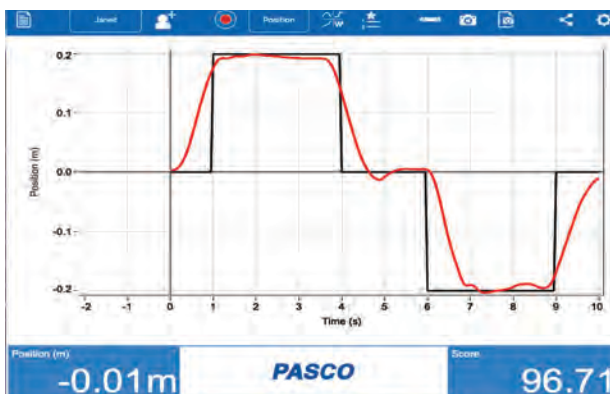
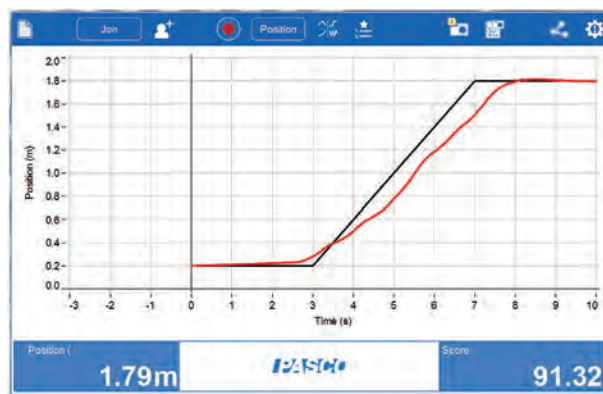

Download the Free MatchGraph! App



for Mac®, Android™, and Windows® computers at pasco.com/downloads. Download the free iPad® or Android™ app on the App Store or Google Play.





Smart Cart (Red/Blue)

ME-1240/ME-1241

The patented Smart Cart is the ultimate tool for studying kinematics, dynamics, Newton's Laws, and more. It is based on a durable ABS body with nearly frictionless wheels, just like our high quality PAScars. Now, we've added built-in sensors that measure force, position, velocity, and acceleration. The versatile Smart Cart can collect measurements on or off a track and transmit the data wirelessly over Bluetooth. In essence, it is a wireless dynamics cart that combines all the necessary sensors, without requiring any additional hardware.

Smart Carts are ideal for studying mechanics topics, such as kinematics and dynamics. The built-in load cells enable two Smart Carts to visually demonstrate Newton's Third Law with ease. Additionally, built-in sensors for force and acceleration enable students to investigate Newton's Second Law in minutes. Smart Carts truly are a physics lab on wheels, and now you can own the most advanced physics cart ever created, all without the restrictions of cables.

Features:

- ▶ Built-in ± 100 N force sensor
- ▶ 3-axis accelerometer
- ▶ Bluetooth® connectivity
- ▶ Rechargeable battery
- ▶ Motion encoder measures position and velocity on or off the track
- ▶ Magnetic bumper for force sensor
- ▶ 3-position plunger
- ▶ Mass tray
- ▶ Velcro® tabs
- ▶ Force sensor hook and rubber bumper

Smart Cart Charging Garage

ME-1243

Charge up to five Smart Carts at once. Provides storage for the carts and accessory bumpers. Includes power adapter.

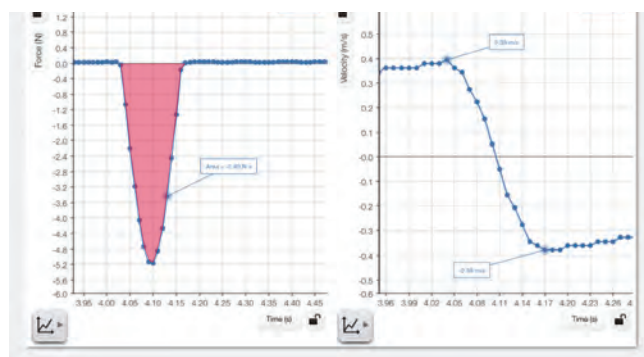

Patent No.
10,481,173

The graphs show the impulse experienced and the change in velocity created by a collision between a Wireless Smart Cart and a cardboard bumper.

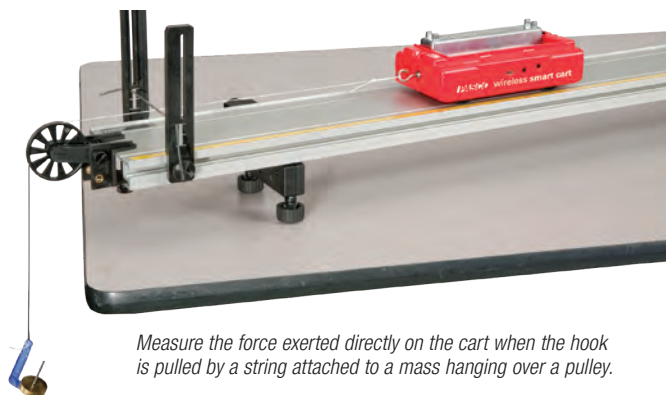

Measure the force exerted directly on the cart when the hook is pulled by a string attached to a mass hanging over a pulley.

Order Information

Smart Cart (Red)	ME-1240
Smart Cart (Blue)	ME-1241
Smart Cart Charging Garage	ME-1243



Smart Cart Demonstration Kits

ME-1272 (RED)/ME-1273 (BLUE)

The Red & Blue Smart Cart Demonstration Kits come with a Smart Cart and all the accessories you need to perform amazing physics demonstrations in kinematics and dynamics.

Features:

- ▶ Smart Cart (red or blue)
- ▶ Smart Fan Accessory
- ▶ Two 250-g Cart Masses
- ▶ Smart Cart Rod Stand Adapter
- ▶ Ballistic Cart Accessory
- ▶ Smart Cart Vector Display
- ▶ Sail
- ▶ Grattells Case
- ▶ Demonstration Manual



Order Information

Red Smart Cart Demonstration KitME-1272
 Blue Smart Cart Demonstration Kit.....ME-1273



Smart Cart Vector Display

ME-1246

The Smart Cart Vector Display adds visual vectors to your Smart Cart for Force, Acceleration, or Velocity. Connect to the Smart Cart's accessory port to visualize vectors in real time! The arrows light up proportional to the sensor reading and indicate both magnitude and positive or negative direction.

Features:

- ▶ Choose from Force, Acceleration, or Velocity vectors, and watch them in real time.
- ▶ Students can visualize constant acceleration as a cart rolls up and then down an incline.
- ▶ Great for the student lab station or for a physics lecture demonstration!
- ▶ Selectable ranges



Order Information

Smart Cart Vector DisplayME-1246



Smart Ballistic Cart Accessory

ME-1245

The Smart Ballistic Cart Accessory mounts to any PASCO dynamics cart for a classic demonstration on the independence of X and Y motion. A projectile fired from the accessory while a cart is in motion will be caught farther down the track. When mounted to a PASCO aluminum cart, or PAScar, the projectile is launched using a push button timer delay. When connected to a PASCO Smart Cart, the Smart Ballistic Accessory can launch the projectile based on measurements made by the Smart Cart in either SPARKvue or PASCO Capstone software.

Features:

- ▶ Compatible with all PASCO dynamics carts
- ▶ Push button timer to delay the launch of the projectile until after the cart is pushed
- ▶ Release mechanism does not affect cart motion or ball flight path
- ▶ The barrel has X and Y adjustments, so perfect vertical projections can be produced every time.
- ▶ Fires a colored nylon ball 0.5 meters or higher for impressive demonstrations
- ▶ Connects to the Smart Cart for measurement-based launching conditions
- ▶ USB rechargeable Li-ion battery



Order Information

Smart Ballistic Cart AccessoryME-1245



Smart Fan Accessory

ME-1242

What makes this fan so smart? If you use this fan on a regular cart, you can turn it on and select one of three speeds by pushing the button on the side. But plugging it into a Smart Cart gives this Smart Fan Accessory added capabilities:

- ▶ **Hands-off Operation:** You can turn the Smart Fan on and off wirelessly from your computing device.
- ▶ **Adjust the Thrust:** Move the slider in the software and watch the fan respond.
- ▶ **Reverse the Spin of the Fan:** Input a negative thrust to make the fan blow in the opposite direction.
- ▶ **Set Start and Stop Conditions:** Choose to start the fan when a measurement (such as Position) reaches a certain value. Make the fan stop after a certain time, so the cart coasts during part of the experiment.
- ▶ **Sense and Control:** Program the Smart Fan thrust to respond to a calculation based on sensor measurements.

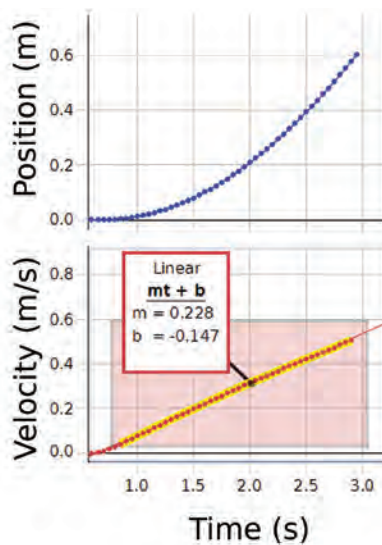

Sample data capture of position and velocity.



Order Information

Smart Fan AccessoryME-1242

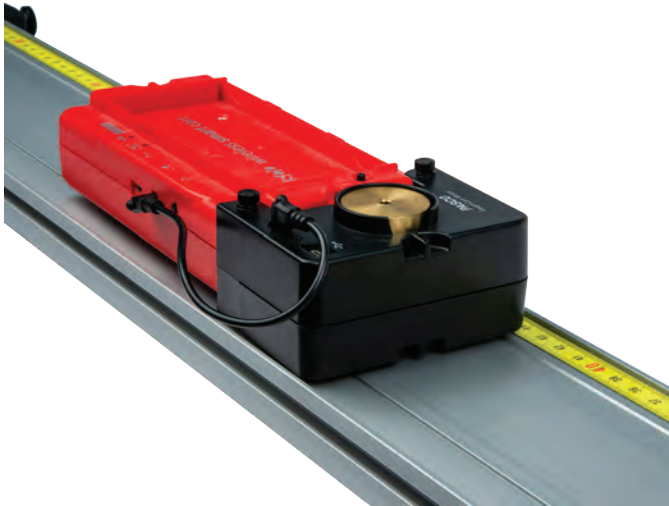

Smart Cart Motor



ME-1247

The Smart Cart Motor is a motor-driven wheel that attaches to the Smart Cart to make it go at a constant velocity, forwards or backwards. In PASCO Capstone or SPARKvue, you can control the motor remotely through its wired connection to the Smart Cart by setting the power on a scale of -100 to +100%.



Order Information

Smart Cart MotorME-1247



Wireless Rotary Motion Sensor



PS-3220

The Wireless Rotary Motion Sensor measures angle, angular velocity, and angular acceleration, as well as their linear equivalents. The included three-step pulley can be rotated at different rates of acceleration, allowing different torques to be applied. You can use the rod-mounting holes to orient the sensor for different experiments. The Wireless Rotary Motion Sensor connects directly to your devices via Bluetooth or USB.

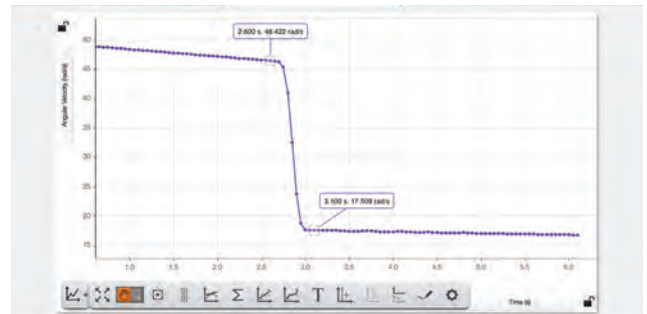

Order Information

Wireless Rotary Motion SensorPS-3220

Wireless Smart Gate



PS-3225

The Wireless Smart Gate has all the features of the wired Smart Gate. It has dual photogate beams spaced at 1.5 cm to accurately measure speed. The built-in laser switch (when used with any laser) allows you to time objects too large to fit through the standard photogate. Pass photogate tape through the photogate slot to measure the movement of objects. The auxiliary port is for adding an additional photogate head or Time-of-Flight Accessory.

We do not recommend using two Wireless Smart Gates in the same experiment unless the measured times are relatively long (greater than one-half second) since synchronization is limited to 2 ms.

Highlights:

- ▶ Dual photogate beams
- ▶ Laser switch
- ▶ Auxiliary photogate/ Time-of-Flight port
- ▶ Photogate tape slot
- ▶ USB and Bluetooth®
- ▶ Rechargeable

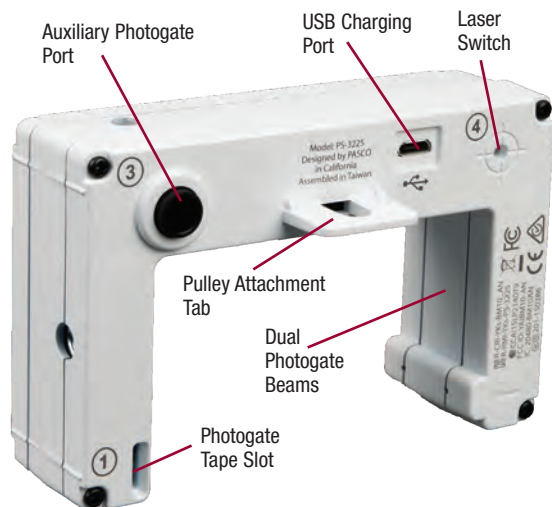

Projectile Launcher

ME-6800

The Projectile Launcher demonstrates the concept that motion in different dimensions is absolutely independent. A good launcher not only illustrates this non-intuitive idea, but also describes the exact motion of the projectile. PASCO has precision-engineered the Projectile Launcher to be durable, accurate, and consistent for highly repeatable results.



Projectile Launcher Wireless Smart Gate System

ME-6796

Choose this wireless option to eliminate cables between the computer and the projectile launcher. The Wireless Smart Gate has all the features of the Smart Gate (PS-2180), but it connects to your computing device via Bluetooth or USB; it does not require an interface.

Includes:

- Wireless Smart Gate with Mounting Bracket
- Launcher with Mounting Stand
- Steel Balls with Loading Rod
- 2-D Collision Accessory
- Aluminum Table Clamp
- 45 cm Stainless Steel Rod

Mini Launcher

ME-6825B

PASCO's Mini Launcher provides a low-cost method for every student to thoroughly investigate projectile motion. The Mini Launcher has the same level of precision and accuracy as our larger Projectile Launcher (ME-6800), but is easier to assemble, simple to adjust, and provides built-in storage for the plunger and metal balls.



Order Information

Wireless Smart Gate	PS-3225
Mini Launcher.....	ME-6825B
Projectile Launcher Wireless Smart Gate System	ME-6796
Projectile Launcher	ME-6800

Wireless Spectrometer (VIS)

PS-2600

The Wireless Spectrometer from PASCO is specifically designed for modern chemistry, biology, and physics labs. With Bluetooth and USB connectivity, students can quickly connect from their device or computer using the free PASCO Spectrometry Software. Scan times are fast, enabling students to gather a full spectrum of data in under one second. After specifying a target wavelength, students can study concentrations (Beer's Law), rates of reactions, or investigate emission spectra using the optional Fiber Optic Cable.

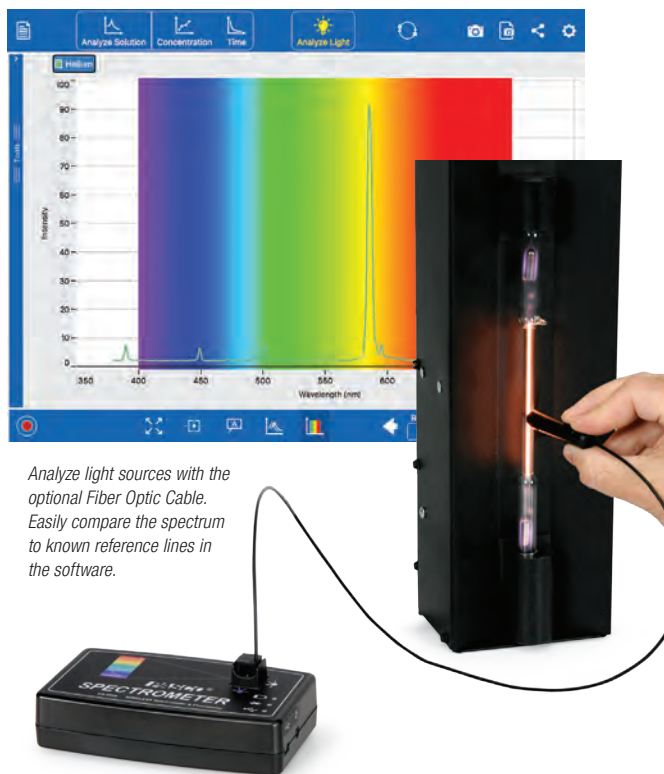

Wireless Sound Sensor

PS-3227

The Wireless Sound Sensor is two sensors in one wireless package: a sound wave sensor capable of measuring changes in relative pressure level as a function of time, and a sound level sensor with both dBA and dBC-weighted scales.

Features:

- ▶ Wireless and portable
- ▶ Wirelessly measure sound wave data at high sample rates (100 kHz)
- ▶ Two sound sensors in one (sound wave and sound level)
- ▶ High quality sensing element intended specifically for laboratory experiments
- ▶ Connects seamlessly to Scope and FFT displays in both SPARKvue and PASCO Capstone software
- ▶ Threaded 1/4-20 socket for easy mounting and alignment/positioning

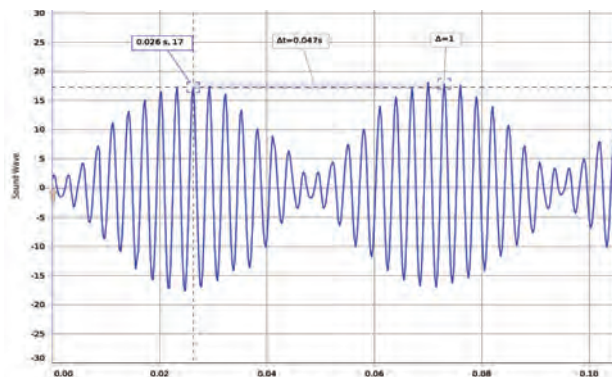

Order Information	
Wireless Spectrometer (VIS).....	PS-2600
Fiber Optic Cable	PS-2601

Order Information	
Wireless Sound Sensor	PS-3227

Wireless Magnetic Field Sensor

PS-3221

This 3-Axis Magnetic Field Sensor can sense the Earth's magnetic field and fields from coils and bar magnets. There are two ranges: ± 50 gauss and ± 1300 gauss. This sensor is primarily for static fields.

Highlights:

- ▶ Simultaneous measurements on three axes
- ▶ **Dual range:** ± 50 G and ± 1300 G
- ▶ Sensitive enough to measure the Earth's magnetic field
- ▶ Measure fields from bar magnets and coils

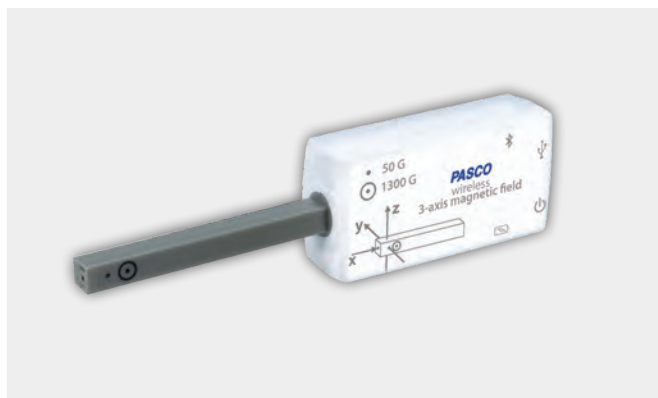
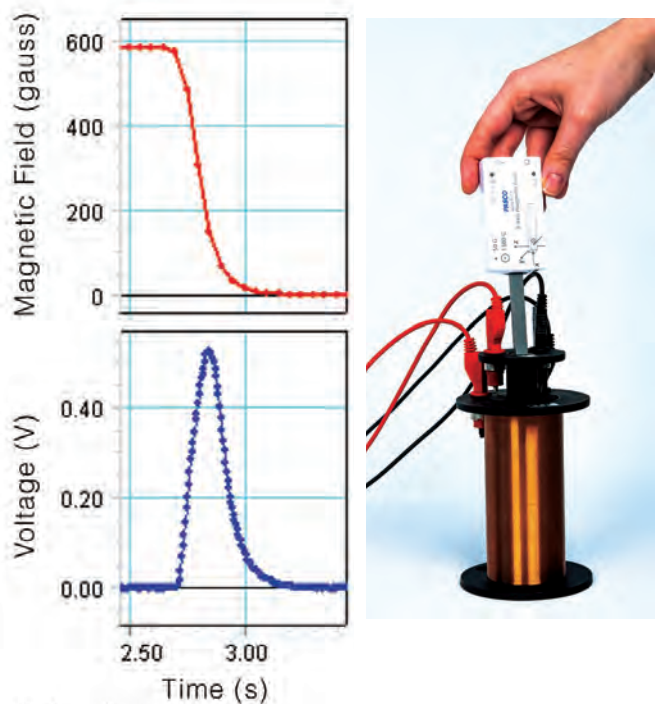

Order Information

Wireless Magnetic Field SensorPS-3221



Wireless Acceleration/Altimeter

PS-3223

The Wireless 3-Axis Acceleration/Altimeter can remotely log acceleration in three dimensions and altitude, making it ideal for recording data during roller coaster rides.

Specifications:

- Accelerometer Ranges: ± 16 g, ± 100 g, ± 200 g, ± 400 g
- Measurements: Acceleration (3 axes and resultant); Altitude; Angular velocity (3 axes)
- Logging: Yes
- Battery: Coin Cell
- Connectivity: Bluetooth 4.0
- Dimensions: 3.02" x 1.6"

Highlights:

- 3-axis accelerometer
- 3-axis gyroscope
- Altimeter
- Rubberized case
- Includes mounting strap

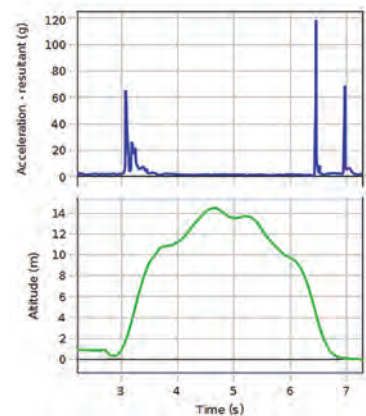

Order Information

Wireless Acceleration/AltimeterPS-3223



Wireless Pressure Sensor

PS-3203

The Wireless Pressure Sensor allows students to easily collect accurate gas pressure data for a wide range of applications. Included is a 60cc syringe, tubing, and connectors that facilitate experiments such as Boyle's Law and measuring pinch-grip strength. Within PASCO's software, students can easily select their desired units from a list containing kPa, mmHg, inHg, mbar, psi, atm, and torr.

Features:

- ▶ Measures pressure even when the pressure within the system drops below ambient pressure
- ▶ Supports common units (kPa, atm, psi, mmHg, or N/m²) for many applications
- ▶ Bluetooth® wireless connectivity and long-lasting rechargeable battery

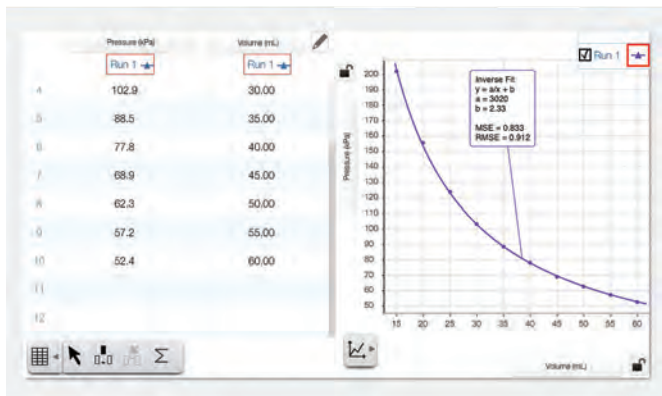

With the included syringe, your students can easily quantify the relationship between pressure and volume.



Order Information

Wireless Pressure SensorPS-3203

Wireless Light Sensor

PS-3213

The Wireless Light Sensor features two separate apertures - one for ambient light measurements and one for directional light measurements. The ambient sensor measures illuminance and UV Index, while the spot (directional) aperture measures light level and color intensity. Our software displays the relative intensities of Red, Green, and Blue light, then sums them to determine the level of White light. PAR and irradiance are also available as calculated measurements within PASCO Capstone (version 1.8 or later) and SPARKvue software (version 2.6 or later).

Features:

- ▶ Wirelessly connects to computers, Chromebooks, tablets, and smartphones
- ▶ Simply pair and go, no cables or adapters to manage
- ▶ On-board memory enables the sensor to function as an independent datalogger
- ▶ Variable sampling rate for short, precise experiments or lengthy, multi-day data collection
- ▶ Bluetooth connectivity and long-lasting coin cell battery
- ▶ Indirect PAR measurements for biological studies



PASCO's Wireless Light Sensor provides students with the tools to explore the electromagnetic spectrum, model planetary motion, study gas laws, and relate photosynthesis to light color and intensity.

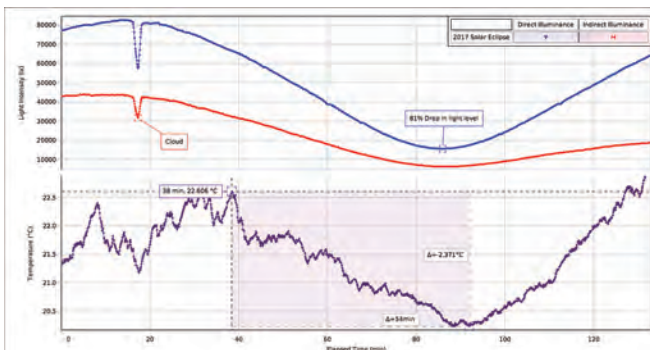

Order Information

Wireless Light SensorPS-3213

NEW

Wireless Geiger Counter



PS-3238

The PASCO Wireless Geiger Counter counts beta, gamma and alpha radiation particles as they enter the Geiger-Müller detector tube inside the counter. Designed for easy mounting, the Geiger Counter provides superior position control in inverse square law labs, as well as an audible beep to indicate the detection of ionizing radiation. The front plastic snout fits conveniently inside the NU-3344 Sample Holder stand (available separately), which stabilizes the front of the counter's detector tube exactly 1 cm from the first slot in the holder. With the Wireless Geiger Counter, students can wirelessly control the high voltage supplied to the Geiger-Müller tube inside the counter, enabling them to make measurements of counts/interval for different tube voltages. They can also plot counts/interval versus tube voltages to experimentally observe the Geiger plateau characteristics of the tube.

Features:

- ▶ Built-in metal mesh screen to protect the delicate mica window in the front of the Geiger-Müller detector tube
- ▶ Audible beep count indication that is easily switched on or off
- ▶ **Versatile positioning options:** either in the NU-3344 Sample Holder, hand-held, or mounted on a rod stand
- ▶ Convenient design to natively fit the PASCO NU-3344 Sample Holder
- ▶ Provides wireless control over the high voltage supplied to the Geiger-Müller tube inside the counter for Geiger plateau experiments

Specifications:

Sensitivity: Alpha, Beta, Gamma

Count Detection: Switchable audio signal

Gas Filling: Ne +Halogen

Effective Tube Diameter: 9.1 mm

Window Thickness: 1.5 to 2.0 mg/cm²

High Voltage Control Range: 150 VDC to 650 VDC

Standard Operating Voltage: 500 VDC

Includes:

- Wireless Geiger Counter
- Micro USB Cable: PS-3584
- Threaded handle for mounting the sensor to a ring stand

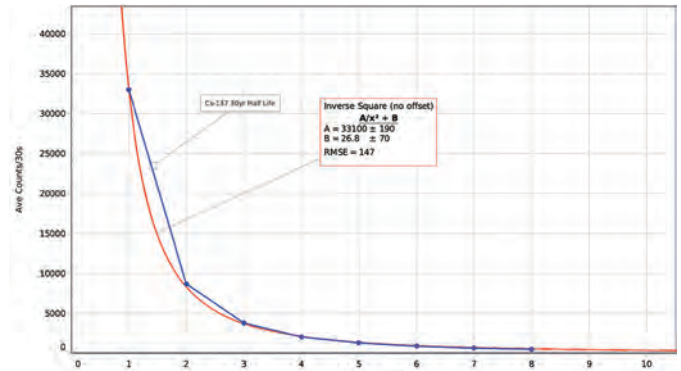

Measure counts/interval from a radioactive source at various distances to explore the inverse square law.

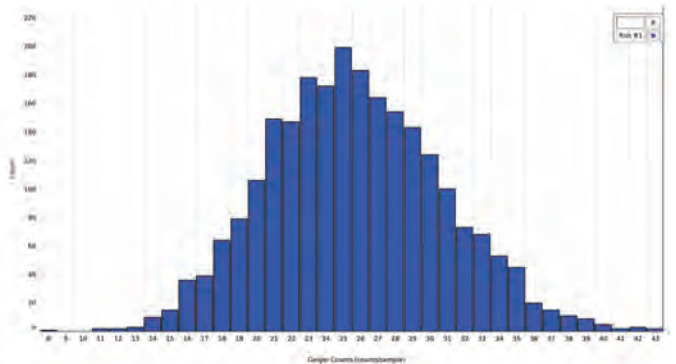

Demonstrate the statistical (gaussian or poisson) nature of counts/interval measured from a radioactive source with long half-life.

NEW

Wireless Geiger Counter shown here with optional PASCO Sample Holder Accessory.



Order Information

Wireless Geiger Counter.....PS-3238

Geiger Counter Sample HolderNU-3344

Wireless Temperature Sensor

PS-3201

Welcome to the modern thermometer. The Wireless Temperature Sensor transmits live data and allows students to continuously monitor, log, and plot temperature measurements on nearly any device. When lab-time ends but the experiment continues, students can set the sensor to log data autonomously for days, weeks, or months, then download it for analysis later. This durable, wireless sensor features a stainless steel probe for the most demanding of applications, as well as a battery that lasts over a year*. It can be used in a wide array of experiments and activities because it measures small, but significant temperature changes produced by chemical reactions, convection currents, and even skin temperatures.



Order Information	
Wireless Temperature Sensor.....	PS-3201

Wireless Current Sensor

PS-3212

The Wireless Current Sensor's wide current range enables introductory and advanced explorations of electricity and circuits. Designed with user safety in mind, the sensor can be used to measure currents up to 1 A and includes built-in overload protection. Collected data can be wirelessly transmitted to computers, Chromebooks, tablets, and smartphones. When combined with a Wireless Voltage Sensor, students can explore Ohm's Law, series and parallel circuits, and much more.

Wireless Voltage Sensor

PS-3211

The Wireless Voltage Sensor is ideal for exploring the fundamental concepts of electricity, voltage, and basic circuits. It measures voltages up to ± 15 V with built-in overload protection, and features high-speed sampling rates when used with a USB. When combined with the Wireless Current Sensor, students can use it to explore Ohm's Law, circuits in series and parallel, and much more.



Order Information	
Wireless Current Sensor	PS-3212
Wireless Voltage Sensor.....	PS-3211



Wireless Force Acceleration Sensor

PS-3202

Capable of simultaneously measuring force, acceleration, and rotational velocity, this sensor is ideal for experiments involving rotating platforms, moving carts, spring oscillations, collisions, and impulse. The wireless design offers improved measurement accuracy by eliminating cords that affect data collection. Students can use the finger-holes for handheld applications, or mount it onto a cart or rod for more complex experiments.

Teaching Advantage:

- ▶ Bluetooth Low Energy and simple, one touch in-app pairing
- ▶ Long-lasting rechargeable battery
- ▶ Zeroing is completed within the software for accurate taring
- ▶ Logging mode stores data for force, acceleration, and rotation directly on the sensor for long-term experiments
- ▶ Simultaneously measures force and acceleration
- ▶ Built-in 3-axis acceleration sensor measures acceleration in x, y, and z axes, and calculates resultant acceleration
- ▶ Built-in gyroscope measures rotation about x, y, and z axes

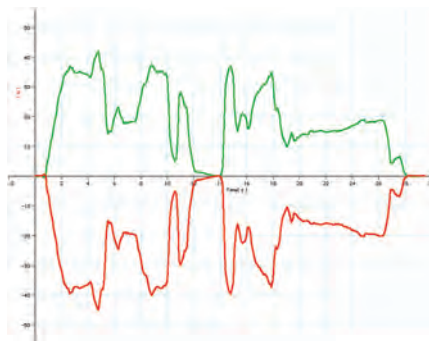

The Wireless Force Acceleration Sensor is perfect for explorations of Newton's 3rd Law.



Order Information	
Wireless Force Acceleration Sensor.....	PS-3202



NEW

Wireless 1 & 2-Axis Force Platforms

PS-3229 & PS-3230

The Wireless Force Platforms build on the success of our PASport Force Platforms, offering users the same reliable performance with enhanced durability and a convenient, wireless connection.

The new design features a sturdy, glass-filled nylon platform and four supporting force beams that measure the forces acting normal to the platform's surface. The Wireless 2-Axis Force Platform also includes a fifth beam for measuring forces parallel to the platform. Along the bottom of each platform are four adjustable feet that make leveling quick and easy, while also ensuring stability between the force beams and the surface below. Students can measure the force applied to each beam independently or the overall resultant force acting on the surface of the platform (up to $\pm 5,200$ N). With their new wireless design, the Wireless Force Platforms are easier to use than ever, providing both spacial flexibility and custom sample rates for high speed sampling over Bluetooth Low Energy (up to 10 kHz).

Features:

- ▶ Improved ruggedized design with increased maximum force range
- ▶ Mechanical force over-limit protection
- ▶ Wide top surface for jumping and standing
- ▶ Burst sampling option for high speed wireless data collection

Specifications:

1-Axis Product Range: $\pm 1,300$ N per beam; $\pm 5,200$ N normal force (resultant)

2-Axis Product Range: $\pm 1,300$ N per beam; $\pm 5,200$ N normal force (resultant); $\pm 1,300$ N parallel force

Surface Dimensions: 35 cm x 35 cm

Maximum Sample Rate: 10 kHz

Resolution: 0.2 N

Force Over-Limit Protection: $\pm 2,000$ N per beam; $\pm 8,000$ N normal force (resultant)

The 2-Axis platform measures the normal and parallel forces acting on the platform simultaneously. Determine the static weight of a structure or person, measure forces associated with the impacts of falling objects, and determine the dynamic vertical and parallel forces that arise when moving or jumping.



Order Information

Wireless Force Platform	PS-3229
Wireless 2-Axis Force Platform	PS-3230
Handle Set, Force Platform.....	PS-2548



SPARK LXi2 Datalogger



PS-3600B

The SPARK LXi2 Datalogger is a Bluetooth, handheld datalogger that enables students to connect wired and wireless sensors, collect data, generate graphs, and analyze results. It is durable, splash-proof, and works seamlessly with PASCO sensors. The SPARK LXi2 can simultaneously accommodate up to five wireless sensors, includes two ports for PASPORT sensors, as well as two ports for the included Fast Response Temperature Probe and Voltage Probe. It can be used with PASCO Wireless sensors, PASPORT sensors and an AirLink, SPARKlink® Air, and the 550 Universal Interface.

Built for Student Use:

- ▶ Portable
- ▶ Shock-absorbing case
- ▶ 8" Color Capacitive Touchscreen (1280 x 800 pixels)
- ▶ 2 GHz Quad Core Processor, 2.0 GB RAM, 32 GB Memory
- ▶ Voltage and temperature sensor ports with included probes
- ▶ Wi-Fi enabled
- ▶ Wireless sensors and Smart Carts connect via Bluetooth®
- ▶ Two PASPORT sensor ports
- ▶ **Loaded with PASCO software:** SPARKvue® for data collection and analysis, MatchGraph!, and Spectrometry software



The SPARK LXi2 features two PASPORT ports as well as ports for the included temperature and voltage probes.



Scan to learn more about the SPARK LXi2



550 Universal Interface

UI-5001

The 550 Universal Interface is fast, powerful, and incredibly affordable. The cost-effective 550 offers half the ports and many of the same features as our 850 Universal Interface, including both Bluetooth and USB connectivity. The 550 Universal Interface includes two PASPORT sensor ports, two digital sensor ports, two analog sensor ports, and a built-in signal generator.

The 550's two digital inputs are compatible with all ScienceWorkshop digital sensors, as well as timing devices, and photogates. The two analog ports connect with our analog ScienceWorkshop sensors and can support a 2.0 MHz max sampling rate and 1.22 mV resolution for voltage sensing.

The 550's built-in signal generator powers motors, speakers, circuits, and many other devices. With PASCO Capstone software and the 550, you can control various DC and AC waveforms, without requiring any other technology. The 550 provides 8 V at 400 mA, selectable voltage limits, built-in voltage and current measurements, and DC offset. Capstone software turns the 550 into a live oscilloscope that can display simultaneous traces.

Beyond having USB 2.0 connectivity, the 550 can also send data wirelessly to any Bluetooth enabled computer, iPad, or Android tablet using PASCO Capstone or SPARKvue software.

Features:

- ▶ USB and Bluetooth connectivity
- ▶ 3.2 W power amplifier
- ▶ 2.0 MHz max sampling rate
- ▶ 100 kHz signal generator with built-in Voltage and Current sensors
- ▶ Compatible with PASPORT, ScienceWorkshop, and Wireless Sensors
- ▶ 2 high-speed analog inputs
- ▶ 2 digital inputs for photogates and other timing sensors
- ▶ 2 PASPORT sensor inputs
- ▶ Can be used simultaneously with other PASPORT interfaces
- ▶ Uses PASCO Capstone™ or SPARKvue® Software



The 550 Universal Interface allows you to connect Science Workshop (analog), PASPORT (USB), and Wireless (Bluetooth®) sensors. It also includes a power amplifier and signal generator (not shown).

Order Information	
SPARK LXi2.....	PS-3600B

Order Information	
550 Universal Interface.....	UI-5001

Interface Comparison

Compare the features and capabilities and see which interface works best in your lab.



	SPARK LXi2 PS-3600B	AirLink PS-3200	SPARKlink Air PS-2011	550 Universal Interface UI-5001
PASPORT Ports	2	1	2	2
Analog Inputs	0	0	0	2 (± 10 V, optional gain voltage 10x, 100x)
Digital Inputs	5	0	0	2
Connects via USB	Yes	Yes	Yes	Yes
Connects via Bluetooth	Yes	Yes	Yes	Yes
Rechargeable battery (for cordless operation only)	Yes	Yes	Yes	No (AC adapter)
Works with PASCO Capstone Software	No	Yes	Yes	Yes
Works with SPARKvue Software	Yes	Yes	Yes	Yes
Accepts PASPORT Sensors	Yes	Yes	Yes	Yes
Accepts ScienceWorkshop Sensors	No*	No*	No*	Yes
Maximum Sampling Rate	Sensor dependent <100 kHz	Sensor dependent <1000 Hz	Sensor dependent <1000 Hz	Up to 2 MHz on one channel
Signal Generator	N/A	N/A	N/A	± 8 V, at 400 mA, DC to 100 kHz
Included Items	Ruggedized case, hands-free stand, SPARKvue, MatchGraph!, Spectrometry	USB Cable	AC adapter, USB cable, fast response temperature and voltage probe	USB cable, Power supply

* The AirLink and SPARKlink Air can accept most ScienceWorkshop sensors with the proper adapter, although they won't have the same high maximum sample rates. One exception is the Sound Sensor (UI-5101), which is not recommended for use with an adapter.

AirLink Interface

PS-3200

The Airlink connects PASPORT sensors to a Mac or Windows computer, Chromebook, iPad, tablet, or smartphone via Bluetooth or USB connection. The USB cable is included.



SPARKlink Air Interface

PS-2011

The SPARKlink® Air allows students and teachers to connect any of our 70+ PASPORT sensors to their device via USB or Bluetooth®.



Order Information

AirLink InterfacePS-3200

Order Information

SPARKlink Air InterfacePS-2011

Make the switch to **PASCO** capstone™ 2

The Most Advanced Data Collection Software in Science Education

PASCO is pushing the limits of technology, so you can push your students to their potential. Working closely with educators, we continuously develop Capstone™, making improvements and enhancing the teaching features. Capstone is designed to handle large data sets, high-speed sampling, and customized preferences to fit the needs of your lab. The straightforward user interface is approachable for beginners, yet Capstone offers all the capabilities needed for even the most advanced users.

Features in PASCO Capstone 2

Visit pasco.com/capstone for more information.

Circuits Emulation

Reinforce circuit concepts and tackle student misconceptions using circuit visualization.

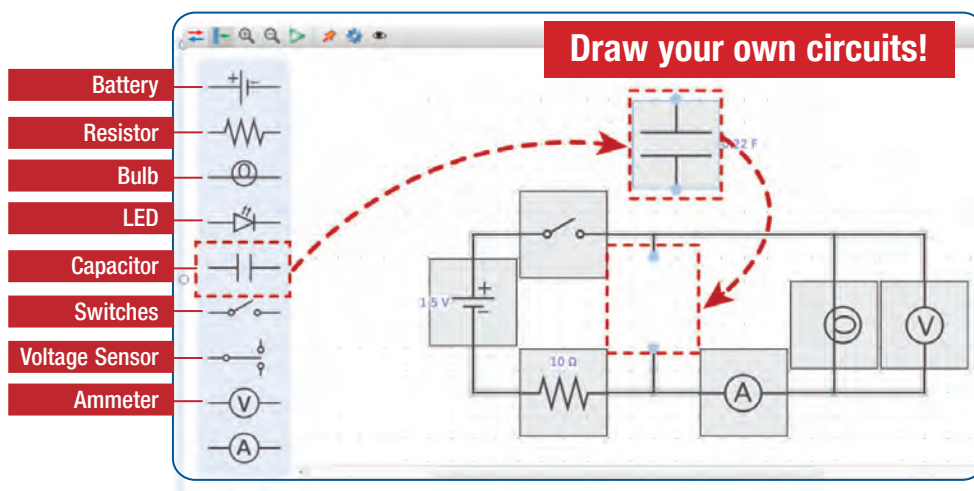

Combine real-world circuits with simulations, animations, and live measurements.

With this tool you can:

- ▶ Construct and modify circuits
- ▶ Show conventional current and electron flow animations
- ▶ Animate circuits with live sensor data

Build your own circuits in Capstone. Drag and drop components and draw wires to connect.

- ▶ Demonstrate series and parallel
- ▶ Charge and discharge capacitors

Examples of other circuit emulations

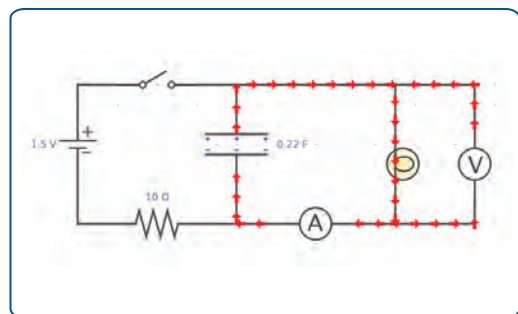

- ▶ Animated conventional current flow
- ▶ Animated capacitor—charge or discharge
- ▶ Edit capacitor values

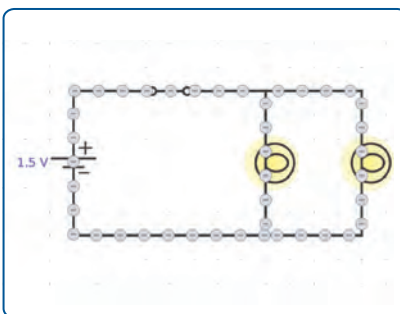

- ▶ Animated electron flow
- ▶ Connect components in parallel or series

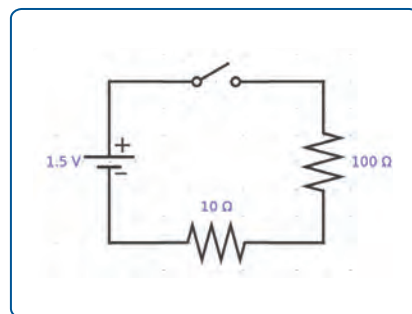

- ▶ Operate switches
- ▶ Edit voltage and resistor values

Blockly Block-based Coding

- ▶ Control all PASCO sensors and interfaces
- ▶ Create sense and control programs
- ▶ Control outputs from sensor inputs

Bring computational thinking into your science lab!

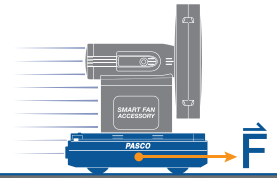

```

Write output voltage Smart Fan Accessory - 0
Sleep in ms 100
set k to -110
set b to 160
set Xo to 0.3
set N to 0
repeat 10000 times
do
change N by 1
set x to Read Measurement Position, Blue m
set v to Read Measurement Velocity, Blue m/s
set P to k x x - Xo - b x v
Write output voltage Smart Fan Accessory - P
Write numeric to UED power - P
Sleep in ms 20
if absolute v 0.1 > and N 100 <
do
set Xo to -1 x Xo
set N to 0
Write output voltage Smart Fan Accessory - 0
    
```

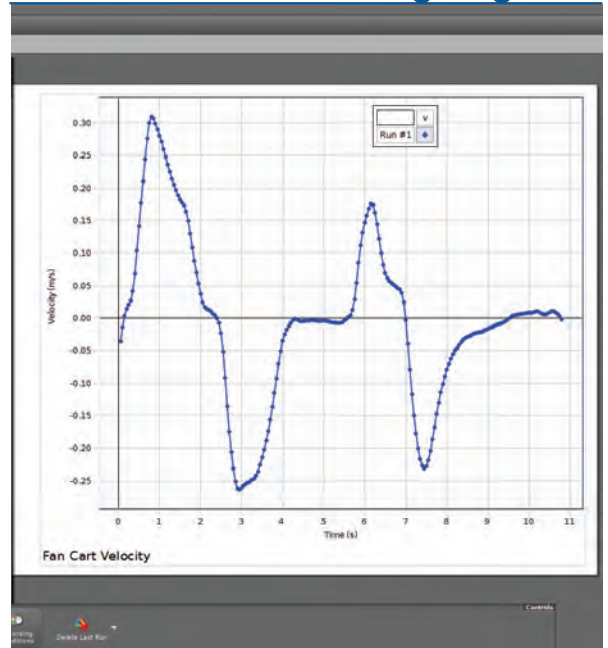

Graph Pop-up Tools

Quick access to commonly used analysis tools

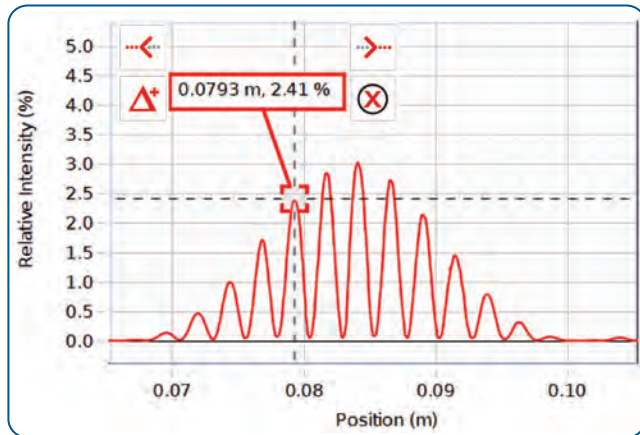

Visit pasco.com/capstone for more information.

Capstone has all the software tools you need for data collection and analysis. And we continue to add more features, based on input from physics educators just like you!

- ▶ Exclude or delete selected data points from analysis.
- ▶ Create models using the calculator.
- ▶ Calculated columns in tables
- ▶ Error bars
- ▶ Weighted linear fit that takes into account error bars
- ▶ More complex curve fits such as damped sine, Gaussian, sine series, and user-entered fits
- ▶ Smooth data directly on a graph with slider tool
- ▶ Global preferences settings

Download the Free Trial
www.pasco.com/Capstone

Requires Mac
or Windows



Order Information

PASCO Capstone Single User License.....	UI-5401
PASCO Capstone Site License.....	UI-5400
PASCO Capstone College/University Dept. Lic.	UI-5406
PASCO Capstone K-12 Campus License.....	UI-5405

TOOLS

Hardware Setup
Configure PASCO Hardware
 Works with PASPORT, ScienceWorkshop, and Wireless Sensors

Timer Setup
Photogate Timer Wizard
 Easily configure photogates and timing measurements

Data Summary
Data Summary
 ▶ Equations/calculations
 ▶ Fundamental constants
 ▶ Experimental constants
 ▶ Trials and runs

Calibration
Sensor Calibration Wizard
 ▶ Step by step calibration
 ▶ Many calibration types

Signal Generator
Signal Generator
 ▶ Scan through a range of frequencies
 ▶ Control signal output with a calculation

Calculator
Calculator
 ▶ Graph modeling
 ▶ Create data sets using sensor data

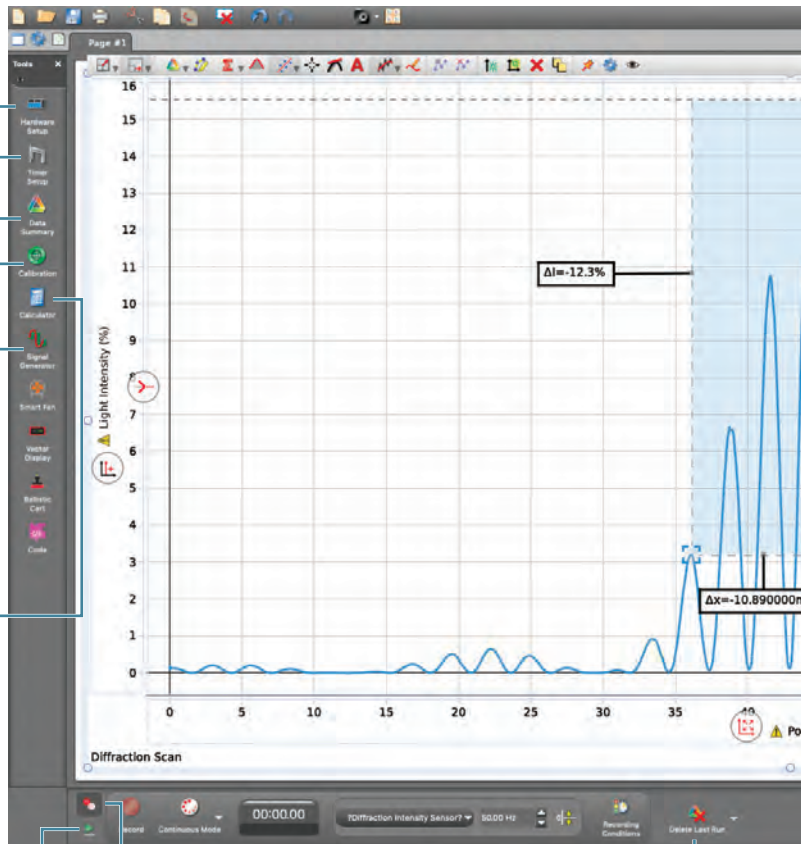

Replay Your Data
 ▶ Change replay rate
 ▶ Increment by frame
 ▶ Loop playback

Sampling Options
 ▶ Continuous manual sampling
 ▶ Fast monitor mode
 ▶ Independent sensor sampling rates
 ▶ Start/stop conditions
 ▶ Zero sensor

Capstone 2 Includes Video Analysis

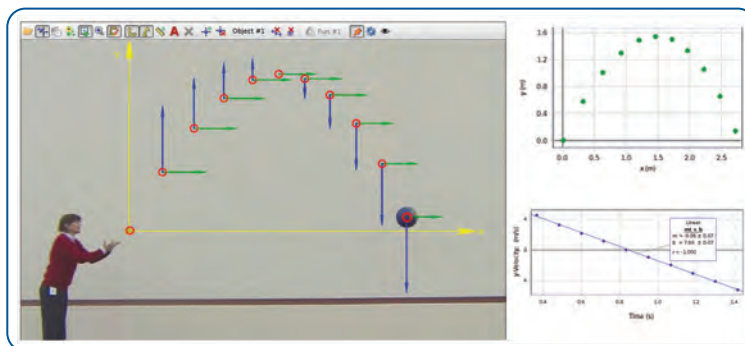

Sophisticated scientific calculator has statistics, calculus, filters, logic functions, and special operations such as amplitude and period.

Import video and analyze the motion of objects to measure position, velocity, and acceleration. With this tool you can also:

- ▶ Show velocity and acceleration vectors
- ▶ Use magnifier to identify exact center of an object
- ▶ Use calibration ruler at any time
- ▶ And so much more!

PASCO's proximity in-app sensor pairing:
 U.S. Patent Number
 10,356,594

DISPLAYS

Display Your Data Your Way

▶ Graph ▶ Table ▶ Digits ▶ Scope ▶ FFT ▶ Meters

Graph Tools Include

- ▶ Draw predictions on graphs before taking data.
- ▶ Multiple y-axes and/or multiple plot areas
- ▶ Perform Quick-Calcs on the graph axis to linearize data.
- ▶ Curve-fits report the uncertainties in the parameters.
- ▶ Multi-coordinate tool gives y-values wherever it intersects data.

Error Bars and Weighted Linear Fits

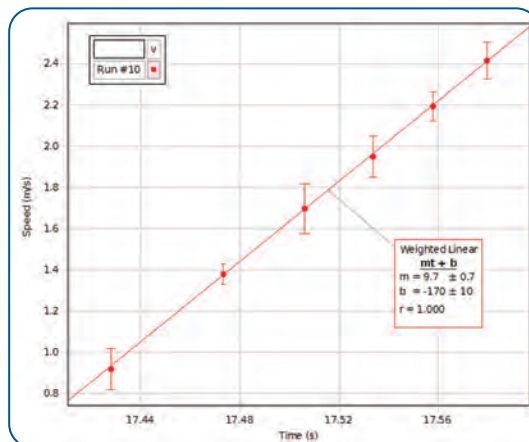

Graph uncertainties using user-entered error bars, absolute error, or percent error. The weighted linear fit incorporates the error bars.

Visit pasco.com/capstone for more information.

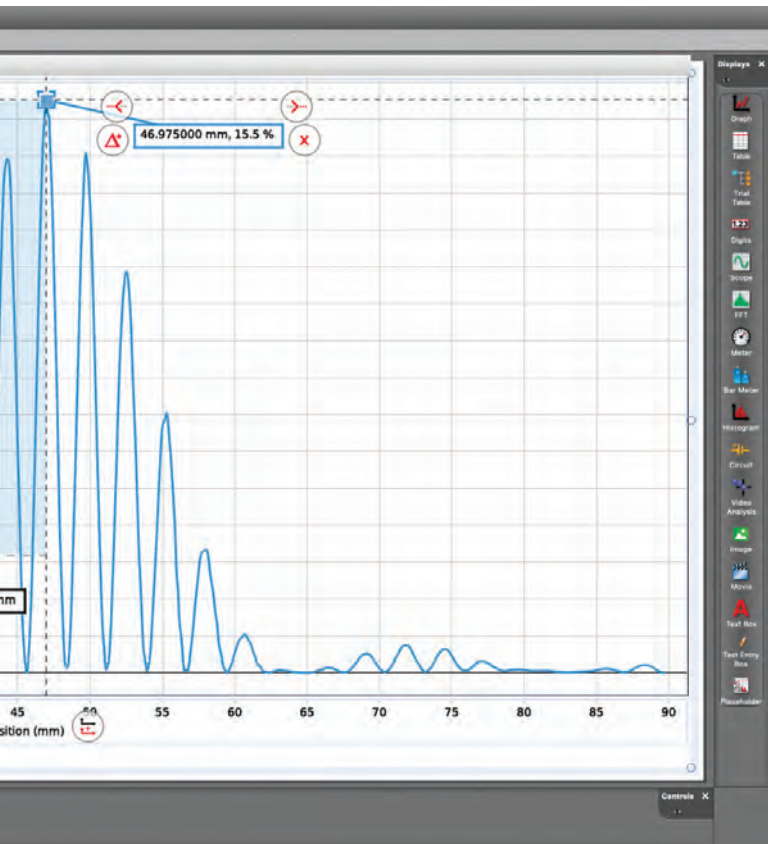

Delete Runs

- ▶ Last run only
- ▶ Select from list
- ▶ All runs

Made a mistake?



Just hit
UNDO

Oscilloscope Display

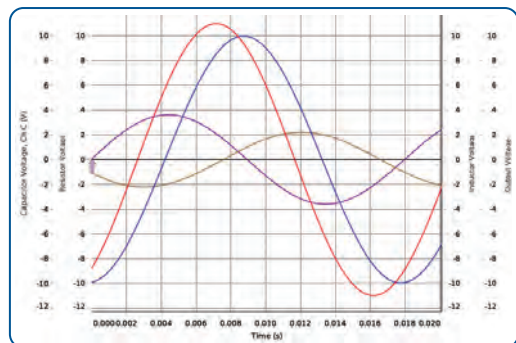

This display behaves like an authentic digital oscilloscope.

- ▶ Trigger
- ▶ Single trace collection
- ▶ Sample rate tied to time axis scale
- ▶ Set trace offset

FFT

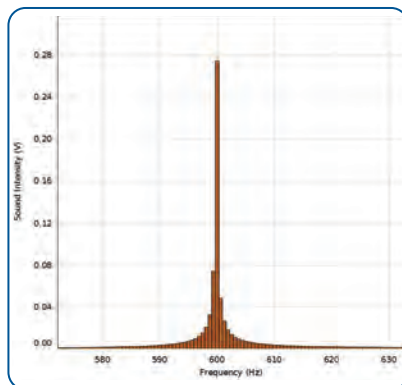

Display data in the frequency domain to find peak frequency and harmonics.

- ▶ Sample rate tied to axis scale
- ▶ Normalize data
- ▶ Adjust BIN width

Multi-Coordinate Tool

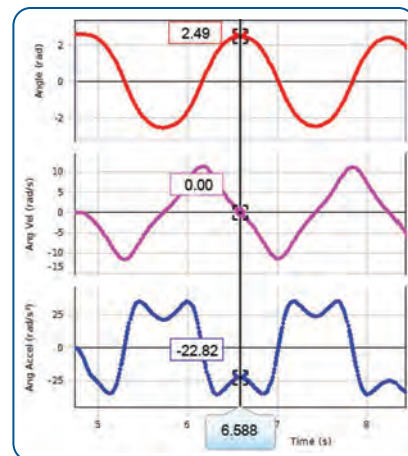

Easily show the relationship between multiple data plots by comparing data values across the time axis.

Sensor Index

WIRELESS SENSORS	Part Number	Page Number
Acceleration/Altimeter	PS-3223	108
Blood Pressure.....	PS-3218	109
CO ₂	PS-3208	109
//code.Node.....	PS-3231	110
Colorimeter & Turbidity	PS-3215	110
Conductivity	PS-3210	111
//control.Node.....	PS-3232	111
Current.....	PS-3212	112
Drop Counter	PS-3214	112
EKG	PS-3236	113
Exercise Heart Rate.....	PS-3207	113
Force Acceleration.....	PS-3202	114
Force Platforms	PS-3229/3230 ..	114
Geiger Counter.....	PS-3238	115
Greenhouse.....	PS-3322	115
Hand-Grip Heart Rate.....	PS-3206	116
Light.....	PS-3213	116
Load Cell Accelerometer.....	PS-3216	117
Magnetic Field 3-Axis	PS-3221	117
Motion.....	PS-3219	118
Optical Dissolved O ₂	PS-3224	118
O ₂ Gas.....	PS-3217	119
pH.....	PS-3204	119
Polarimeter.....	PS-3237	120
Pressure	PS-3203	120
Rotary Motion.....	PS-3220	121
Smart Gate.....	PS-3225	121
Smart Cart (red).....	ME-1240	122
Smart Cart (blue)	ME-1241	122
Soil Moisture.....	PS-3228	123
Sound	PS-3227	123
SPARK LXi2.....	PS-3600	124
SPARKlink Air	PS-2011	125
Spectrometer	PS-2600	125
Spirometer.....	PS-2600	126
Temperature	PS-3222	126
Temperature Link.....	PS-3201	126
Voltage	PS-3211	127
Weather with GPS	PS-3209	127

PASCO's 5-Year Educational Warranty

To withstand the rigors of student use, PASCO products are made of the highest quality materials. And we back up our products with a 5-year warranty, so you can be completely confident about buying PASCO solutions.



Wireless Acceleration/Altimeter

PS-3223

The Wireless 3-Axis Acceleration/Altimeter can remotely log acceleration in three dimensions and altitude, making it ideal for recording data during roller coaster rides.

Highlights:

- 3-axis accelerometer
- 3-axis gyroscope
- Altimeter
- Rubberized case

Specifications:

Accelerometer Ranges: ±16 g, ±100 g, ±200 g, ±400 g

Measurements: Acceleration (3 axes and resultant); Altitude; Angular velocity (3 axes)

Battery: Coin Cell

Connectivity: Bluetooth 4.0

Logging: Yes

Includes:

- Sensor with rubberized case
- Adjustable strap

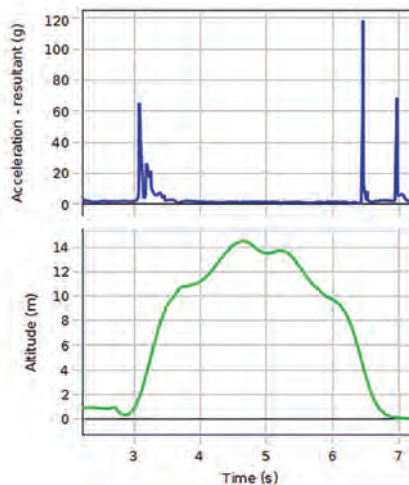

Order Information

Wireless Acceleration/Altimeter.....PS-3223



Wireless Blood Pressure Sensor

PS-3218

PASCO's Wireless Blood Pressure Sensor allows students to quickly and easily measure both systolic and diastolic arterial blood pressure (mmHg) as well as heart rate (pulse in bpm). Comparing the digits display for systolic and diastolic pressure with the display of blood pressure from the real-time graph helps students gain a contextual understanding of the physiology of blood pressure.

Applications:

- ▶ Determine effects of exercise on blood pressure and heart rate
- ▶ Compare the blood pressure and heart rate of different students in the class
- ▶ Explore effects of body position on blood pressure & heart rate

Specifications:

Heart Rate Range: 36 to 200 bpm

Heart Rate Accuracy: ±1 bpm

Heart Rate Resolution: 1 bpm

Blood Pressure Range: 0 to 375 mmHg

Blood Pressure Accuracy: ±3 mmHg

Blood Pressure Resolution: 0.05 mmHg

Gauge Pressure Units: mmHg, N/m², kPa, atm, psi

Gauge Pressure Range: 0 to 375 mmHg

Gauge Pressure Accuracy: ±3 mmHg

Gauge Pressure Resolution: 0.05 mmHg

Logging: No

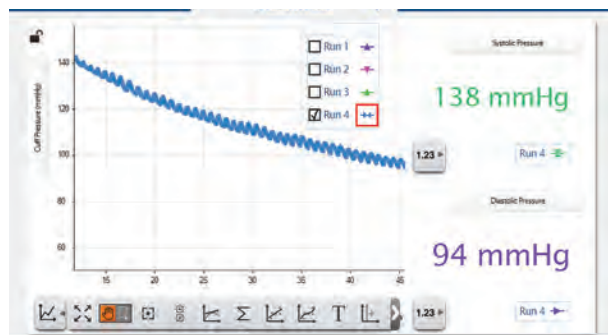

Order Information

Wireless Blood Pressure Sensor with Standard Cuff..... PS-3218



Wireless CO₂ Sensor

PS-3208

Measure changes in carbon dioxide (CO₂) gas levels quickly and easily with the Wireless CO₂ Sensor. The sensor is temperature compensated and can operate in high humidity environments. It employs live data to make core labs, such as photosynthesis, cellular respiration, and metabolism experiments engaging and impactful. With the ability to store more than 55,000 data points, this sensor enables studies to run overnight or throughout an entire weekend, making it ideal for long-term, carbon cycling investigations. The included 250-ml sample bottle supports analyses with multiple gas sensors.

Features:

- ▶ Logging ability for long-term experiments, store up to 55,000 data points
- ▶ Integrated stopper for use with included sample bottle and common glassware
- ▶ Temperature compensated for accurate results

Demonstrate:

- ▶ Respiration in compost or other decomposer rich environments
- ▶ Carbohydrate consumption rates due to human activity
- ▶ Monitor CO₂ levels during photosynthesis and respiration experiments
- ▶ Study carbon cycling in a model ecosystem
- ▶ Monitor CO₂ levels for indoor air quality
- ▶ Measure carbon flux in aquatic environments with the waterproof sleeve

Specifications:

Range: 0 to 100,000 ppm

Resolution: 2 ppm

Connection: Bluetooth 4.0 or USB

Battery life: ≥18 hours of continuous use

Accuracy: 0 to 1,000 ppm: ±100 ppm, 1,000 to 10,000 ppm: ±5% of reading + 100ppm, 10,000 ppm to 50,000 ppm: ±10% of reading, 50,000 - 100,000 ppm: ±15% of reading

Warm-up time: 3 min

Response time: 90% in 30 sec

Logging: Yes

Order Information

Wireless CO₂ Sensor.....PS-3208

Wireless CO₂ Sensor PackPS-3341



//code.Node

PS-3231

The //code.Node is a turnkey coding solution that combines real-world sensor inquiry, Blockly coding, and live data displays to drive computational thinking in STEM learning. It includes six interactive sensors and four device outputs that measure and respond to phenomena using code created in SPARKvue or Capstone software.

Specifications:

Light Level Sensor Range: Visible Spectrum (400 nm to 700 nm)

Light Level Sensor Sensitivity: Approximately 600 lx to 50,000 lx (not calibrated)

Sound Level Sensor Sensitivity: Approximately 70 dB to 100 dB (not calibrated)

Magnetic Field Sensor Range: ± 50 gauss

Acceleration Sensor Range: 2-axes, ± 8 g

Ambient Temperature Range: -25°C to 40°C

Ambient Temperature Resolution: 0.05°C

Ambient Temperature Accuracy: $\pm 1^{\circ}\text{C}$

Maximum Sample Rate: 100 Hz

Momentary Push Buttons (2): On/Off

Speaker Output Frequency Range: 10 Hz to 10,000 Hz

Multi-color LED: Independently adjust intensity of Red, Green, Blue

Logging: No



Wireless Colorimeter & Turbidity Sensor

PS-3215

The Wireless Colorimeter & Turbidity Sensor simultaneously measures the absorbance and transmittance of six different wavelengths. The sensor can be used to study Beer's Law (absorbance vs. concentration), enzyme activity, photosynthesis, and the rates of chemical reactions (absorbance vs. time). After a simple calibration, students can quickly begin viewing live measurements as they materialize across the visible spectrum at 650 nm (red), 600 nm (orange), 570 nm (yellow), 550 nm (green), 500 nm (blue), and 450 nm (violet).

This sensor also functions as a high-quality turbidimeter for water quality analysis. Rather than simply measuring transmitted light, the Wireless Colorimeter and Turbidity Sensor measures light scattered at a 90 degree angle from the sample, resulting in accurate and repeatable measurements. Calibration curves for the EZ-Sample water quality concentrations can now be reported in parts per million (PPM) directly from software.

Features:

- ▶ Stabilized light source for consistent readings
- ▶ Measures six different wavelengths simultaneously
- ▶ PASCO software displays the absorbance & transmittance at each wavelength in the appropriate color
- ▶ Directly calibrated to read EZsample Snap Vial concentrations of Ammonia, Nitrate, Phosphate, Iron and Chlorine in ppm.
- ▶ Functions as both a colorimeter and turbidimeter

Specifications:

Color detection/peak wavelengths: 650 nm (red), 600 nm (orange), 570 nm (yellow), 550 nm (green), 500 nm (blue), 450 nm (violet)

Detector ranges: ± 25 nm from peak

Absorbance: 0–3 Abs units; useful range (0.05–1.5 Abs)

Transmittance: 0–100%

Turbidity range: 0–400 NTU

Accuracy: $\pm 5\%$ NTU

Logging: Yes



WARNING! This product can expose you to chemicals including Formaldehyde, which is known to the State of California to cause cancer. For more information go to www.P65Warnings.ca.gov.

Order Information

//code.Node	PS-3231
//code.Node Holder	PS-3233
//code.Node Multi-pack (Set of 8)	PS-3311

Order Information

Wireless Colorimeter & Turbidity Sensor	PS-3215
Wireless Colorimeter & Turbidity Sensor Pack	PS-3334



Wireless Conductivity Sensor

PS-3210

The Wireless Conductivity Sensor measures the electrical conductivity of an aqueous solution. It is ideal for investigating the properties of solutions, including total dissolved solids (TDS) for water quality inquiry. Because it is temperature compensated, calibrations are less frequent and can be applied across a range of temperatures. With a range of 0 to 20,000 $\mu\text{S/cm}$, this sensor can be utilized for chemical, biological, and environmental studies.

Teacher tip: To measure brackish or marine samples above sensor range, perform a 10:1 distilled to salt water solution then multiply sample conductivity x 10.

Features:

- ▶ Measure conductivity and total dissolved solids
- ▶ Automatic temperature compensation
- ▶ Battery life >1 year
- ▶ Remote logging with built-in memory
- ▶ Dust-proof, sand-proof, and water-resistant (1 meter for 30 minutes)

Specifications:

- Range:** 0 to 20,000 $\mu\text{S/cm}$ (0 to 10,000 mg/L TDS)
- Accuracy from 200 $\mu\text{S/cm}$ to 20,000 $\mu\text{S/cm}$:** $\pm 10\%$ of value
- Accuracy below 200 $\mu\text{S/cm}$:** qualitative
- Resolution:** 0.1 $\mu\text{S/cm}$
- Response time:** 95% of final reading in 5 seconds or less
- Probe Environmental Tolerance (Min-Max):** 0-80°C
- Temperature Compensation:** 0-35°C
- Probe Material:** The probe is composed of 300 series stainless steel and glass filled polypropylene
- Waterproof:** IP-X7 rated (1m for 30min)

Order Information

- Wireless Conductivity SensorPS-3210
- Wireless Conductivity Sensor Pack.....PS-3332

//control.Node



PS-3232

The //control.Node provides power and controls stepper motors, servo motors, and other accessories.

Built-in Features:

- ▶ Two Power Output Channels for Stepper Motors and Power Output Board
- ▶ Two Servo Ports for Regular Servos and Continuous Rotation Servos
- ▶ Accelerometer
- ▶ Speaker
- ▶ Sensor Port
- ▶ Rechargeable Lithium Ion Battery
- ▶ Bluetooth BLE Communication
- ▶ USB Port for Charging and Communication
- ▶ Two 6-32 Threaded Holes for Mounting
- ▶ PASCObot Sense and Control Kit
- ▶ Greenhouse Sense and Control Kit
- ▶ //control.Node Sense and Control Kit
- ▶ Stepper Motors
- ▶ Servo Motors (Standard and Continuous Rotation)
- ▶ Power Output Module
- ▶ Greenhouse Sensor
- ▶ PASCObot

Specifications:

- Two Power Output Ports:** ± 5 VDC, 0.7 A, Auto-ID stepper motors and Power Output Module
- Two Servo Ports:** Accepts standard servos and continuous rotation servos, 3-pin connector, built-in servo current sensor for detecting load
- Sensor Port:** I2C
- Onboard Acceleration Sensor:** 3-axis, $\pm 16g$
- Rechargeable Battery:** 3.7 mA-hr LiPo (3C), USB chargeable
- Communication:** Bluetooth BLE or USB
- Speaker:** For audible beep when code is uploaded
- Dimensions:** 11.5 x 5 x 3 cm
- Mass:** 142 g

Order Information

- //control.Node.....PS-3232



Wireless Current Sensor

PS-3212

The Wireless Current Sensor's wide current range enables introductory and advanced explorations of electricity and basic circuits. Designed with user safety in mind, the sensor can be used to measure currents up to 1 A and includes built-in overload protection. Collected data can be wirelessly transmitted to computers, Chromebooks, tablets, and smart phones. When combined with a Wireless Voltage Sensor, students can explore Ohm's Law, series and parallel circuits, and much more.

Features:

- ▶ **Two Ranges:** ± 1.0 A and ± 0.1 A
- ▶ **Resolution:** 0.2 mA at ± 1 A range and 0.02 mA at ± 0.1 A range
- ▶ High-speed sampling
- ▶ Remote logging with built-in memory
- ▶ Variable sampling rate for recording small, fast changes or experiments that run for hours, days, or weeks

Specifications:

High Setting Range: ± 1 A

Low Setting Range: ± 0.1 A

Resolution: 0.2mA (± 1 A range); 0.02mA (± 0.1 A range)

Maximum Sampling Rate: 100 kHz

Input Resistance: 0.1 Ω

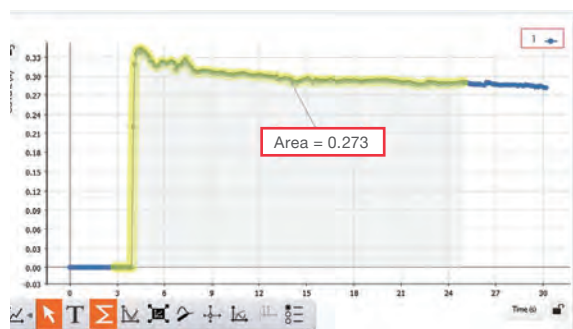

Wireless Drop Counter

PS-3214

The Wireless Drop Counter has a wider (18 x 13 mm) drop window for better drop detection and easier alignment with burettes. It works equally well with large or small, fast or slow drops.

Measures up to 10 drops per second, with drops as small as 0.5 mm.

Teaching Advantage:

- ▶ IR filter assures accurate counts because room lighting cannot affect results
- ▶ Sensor unit can suspend two other probes in solution, simplifying many experiments
- ▶ Wider drop window (18 x 13 mm) means better drop detection and easier alignment with burettes

Specifications:

Maximum Drop Count Rate: 10 drops/second

Exterior Case: ABS Plastic

Optical Window: Acrylic

Logging: Yes

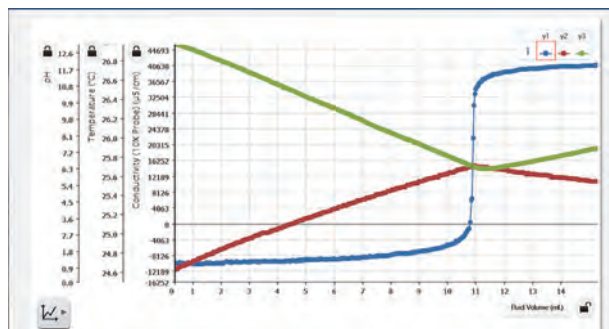

Order Information

Wireless Current SensorPS-3212

Wireless Current Sensor PackPS-3336

Order Information

Wireless Drop CounterPS-3214



Wireless EKG Sensor



PS-3236

The Wireless EKG Sensor measures electrical signals produced by contractions of the heart or muscles, and reports them in real-time on virtually any student device. The perfect sensor for fast-paced physiology courses, the EKG Sensor provides students with real-time feedback as they explore the effects of various stimuli on cardiac or muscular activity. Heart Rate data is reported in beats per minute (BPM), while the voltage (mV) detected from cardiac contractions is intuitively displayed in an EKG trace. The sensor can also be used to study nerve impulses that affect muscles other than the heart, enabling students to study a wider range of physiological phenomena, including reflexes, muscle fatigue and more.

Specifications:

Voltage Range: 0 to 4.5 mV

Voltage Resolution: 5 μ V

Default Sample Rate: 250 Hz

Maximum Sample Rate: 1000 Hz

Heart Rate Range: 40 to 250 bpm

Heart Rate Resolution: 1 bpm

Logging: Yes

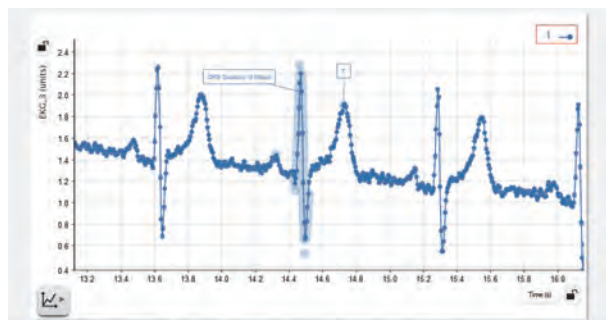

Wireless Exercise Heart Rate Sensor



PS-3207

The Wireless Exercise Heart Rate Sensor has a chest strap and will transmit data wirelessly up to 10 m away! The electrode belt fits around the ribcage (worn against the skin for best results, but can be worn over a shirt if a drop of saline solution is applied under the electrodes). Live and recorded data can be analyzed using any device with PASCO software installed.

Applications:

- ▶ Compare a student's heart rate before, during, and after exercise
- ▶ Calculate recovery rate after physical activity
- ▶ Determine the effects of mild stimulants (e.g. caffeine)
- ▶ Investigate how heart rate changes when a student sits, reclines, stands or moves suddenly

Includes:

- Bluetooth Heart Rate Module
- Coin cell battery
- Chest strap (M-XXL)

Logging: Yes



A single data set shows heart rate during and after exertion.

Order Information

Wireless EKG Sensor.....PS-3236

Order Information

Wireless Exercise Heart Rate Sensor.....PS-3207



Wireless Force Acceleration Sensor

PS-3202

Capable of simultaneously measuring force, acceleration, and rotational velocity, this sensor is ideal for experiments involving rotating platforms, moving carts, spring oscillations, collisions, and impulse. The wireless design offers improved measurement accuracy by eliminating cords that affect data collection. Students can use the finger-holes for handheld applications, or mount it onto a cart or rod for more complex experiments.

Teaching Advantage:

- ▶ Bluetooth Low Energy and simple, one touch in-app pairing
- ▶ Long-lasting rechargeable battery
- ▶ Zeroing is completed within the software for accurate taring
- ▶ Logging mode stores data for force, acceleration, and rotation directly on the sensor for long-term experiments
- ▶ Simultaneously measures force and acceleration
- ▶ Built-in 3-axis acceleration sensor measures acceleration in x, y, and z-axes, and calculates resultant acceleration
- ▶ Built-in gyroscope measures rotation about x, y, and z-axes

Typical Experiments:

- ▶ Impulse and momentum
- ▶ Determining static and kinetic friction coefficients
- ▶ Measuring centripetal acceleration and centripetal force
- ▶ Newton's Third Law
- ▶ Newton's Second Law
- ▶ Hooke's Law
- ▶ Acceleration and crash cushions

Specifications:

Force Range: ± 50 N

Force Resolution: 0.03 N

Accuracy: 0.1 N

Acceleration Range: ± 16 g

Angular Rotation Rate Range: up to ± 2000 degrees per second

Battery: Rechargeable Lithium Polymer

Logging: Yes

Connectivity: Bluetooth 4.0



NEW

Wireless 1 & 2-Axis Force Platforms

PS-3229 & PS-3230

The Wireless Force Platforms build on the success of our PASport Force Platforms, offering users the same reliable performance with enhanced durability and a convenient, wireless connection.

The new design features a sturdy, glass-filled nylon platform and four supporting force beams that measure the forces acting normal to the platform's surface. The Wireless 2-Axis Force Platform also includes a fifth beam for measuring forces parallel to the platform. Along the bottom of each platform are four adjustable feet that make leveling quick and easy, while also ensuring stability between the force beams and the surface below. Students can measure the force applied to each beam independently or the overall resultant force acting on the surface of the platform (up to $\pm 5,200$ N). With their new wireless design, the Wireless Force Platforms are easier to use than ever, providing both spacial flexibility and custom sample rates for high speed sampling over Bluetooth Low Energy (up to 10 kHz).

Features:

- ▶ Improved ruggedized design with increased maximum force range
- ▶ Mechanical force over-limit protection
- ▶ Wide top surface for jumping and standing
- ▶ Burst sampling option for high speed wireless data collection

Specifications:

1-Axis Product Range: $\pm 1,300$ N per beam; $\pm 5,200$ N normal force (resultant)

2-Axis Product Range: $\pm 1,300$ N per beam; $\pm 5,200$ N normal force (resultant); $\pm 1,300$ N parallel force

Surface Dimensions: 35 cm x 35 cm

Maximum Sample Rate: 10 kHz

Resolution: 0.2 N

Force Over-Limit Protection: $\pm 2,000$ N per beam; $\pm 8,000$ N normal force (resultant)

The 2-Axis platform measures the normal and parallel forces acting on the platform simultaneously. Determine the static weight of a structure or person, measure forces associated with the impacts of falling objects, and determine the dynamic vertical and parallel forces that arise when moving or jumping.



Order Information

Wireless Force Platform	PS-3229
Wireless 2-Axis Force Platform	PS-3230
Handle Set, Force Platform.....	PS-2548

Order Information

Wireless Force Acceleration Sensor.....	PS-3202
Wireless Force Acceleration Sensor Pack	PS-3339



NEW

Wireless Geiger Counter shown here with optional PASCO Sample Holder Accessory.

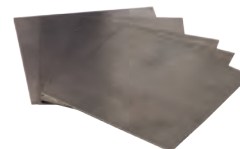

Wireless Geiger Counter  **NEW**

PS-3238

The PASCO Wireless Geiger Counter counts beta, gamma and alpha radiation particles as they enter the Geiger-Müller detector tube inside the counter. Designed for easy mounting, the Geiger Counter provides superior position control in inverse square law labs, as well as an audible beep to indicate the detection of ionizing radiation. The front plastic snout fits conveniently inside the NU-3344 Sample Holder stand (available separately), which stabilizes the front of the counter's detector tube exactly 1 cm from the first slot in the holder. With the Wireless Geiger Counter, students can wirelessly control the high voltage supplied to the Geiger-Müller tube inside the counter, enabling them to make measurements of counts/interval for different tube voltages. They can also plot counts/interval versus tube voltages to experimentally observe the Geiger plateau characteristics of the tube.

Features:

- ▶ Built-in metal mesh screen to protect the delicate mica window in the front of the Geiger-Müller detector tube
- ▶ Audible beep count indication that is easily switched on or off
- ▶ **Versatile positioning options:** either in the NU-3344 Sample Holder, hand-held, or mounted on a rod stand
- ▶ Convenient design to natively fit the PASCO NU-3344 Sample Holder
- ▶ Provides wireless control over the high voltage supplied to the Geiger-Müller tube inside the counter for Geiger plateau experiments

Specifications:

- Sensitivity:** Alpha, Beta, Gamma
- Count Detection:** Switchable audio signal
- Gas Filling:** Ne +Halogen
- Effective Tube Diameter:** 9.1 mm
- Window Thickness:** 1.5 to 2.0 mg/cm²
- High Voltage Control Range:** 150 VDC to 650 VDC
- Standard Operating Voltage:** 500 VDC

Includes:

- Wireless Geiger Counter
- Micro USB Cable: PS-3584
- Threaded handle for mounting the sensor to a ring stand

Greenhouse Sensor  **NEW**

PS-3322

Students can use the greenhouse sensor to monitor light intensity, atmospheric humidity, and container temperature as well as soil moisture conditions in either PASCO's Greenhouse Sense and Control Kit (PS-2997) or your own classroom terrarium. Sense these conditions through blockly and the //control.Node to control other products like the Grow Light (PS-3347), the USB Fan (PS-6206), or the USB Pump (SE-6208) to keep growing conditions ideal.

Specifications:

- Operating Temperature:** -40 to 80°C
- Light Level Sensor Range:** Visible Spectrum (400 nm to 700 nm)
- Light Level Sensor Sensitivity:** Approximately 600 lx to 50,000 lx (not calibrated)
- Ambient Temperature Resolution:** 0.01°C
- Ambient Temperature Range:** -40°C to 80°C
- Ambient Temperature Accuracy:** ±0.5°C
- Humidity Sensor Range:** 0 to 95% non condensing
- Humidity Accuracy:** ±3%
- Humidity Resolution:** ±0.02 %
- Temp, Light, Humidity sensor power use:** 0.98 mA at 3.3 V DC
- Soil Moisture Sensor Range:** 0 to 45%
- Soil Moisture Accuracy:** ±5%
- Soil Moisture Resolution:** 0.1%
- Soil Moisture Power Use:** 3 mA at 5 V DC
- Soil Moisture probe cable length:** 2m

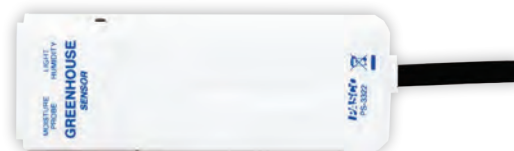

Order Information

Wireless Geiger Counter.....PS-3238
 Geiger Counter Sample HolderNU-3344

Order Information

Greenhouse Sensor.....PS-3322



Wireless Hand-Grip Heart Rate Sensor

PS-3206

With these wireless hand grips, conducting physiology labs on the cardiovascular system or homeostasis is easier than ever before. Continuously monitor heart rate during exercise, or use the sensor to take initial and final measurements with fast and reliable heart-rate detection.

Applications:

- ▶ Determine effects of exercise on heart rate
- ▶ Compare the heart rate of different students in the class
- ▶ Explore effects of body position on heart rate

Replacement Accessories:

- ▶ Replacement Hand Grips PS-3565
- ▶ Coin Cell Battery Pack PS-3504
- ▶ Wireless Hand-Grip Heart Rate Sensor Storage Tray PS-3597

Includes:

- Hand Grips
- Bluetooth Heart Rate Module
- Coin Cell Battery

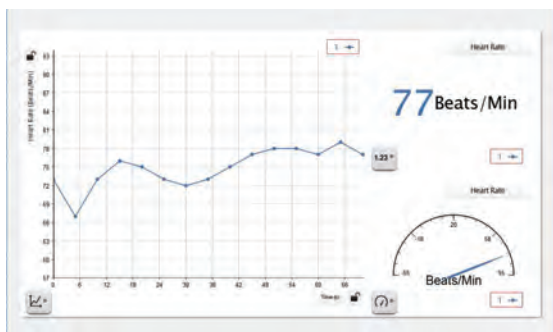

Compare students' heartbeats during a variety of activities.



Wireless Light Sensor

PS-3213

The Wireless Light Sensor features two separate apertures - one for ambient light measurements and one for directional light measurements. The ambient sensor measures illuminance and UV Index, while the spot (directional) aperture measures light level and color intensity. Our software displays the relative intensities of Red, Green, and Blue light, then sums them to determine the level of White light. The light available to drive photosynthesis (PAR) and total light power per area (irradiance) are also available as calculated measurements within PASCO Capstone (version 1.8 or later) and SPARKvue software (version 2.6 or later).

Features:

- ▶ Wirelessly connects to computers, Chromebooks, tablets, and smartphones
- ▶ Simply pair and go, no cables or adapters to manage
- ▶ On-board memory enables the sensor to function as an independent datalogger
- ▶ Variable sampling rate for short, precise experiments or lengthy, multi-day data collection.
- ▶ Bluetooth connectivity and long-lasting coin cell battery
- ▶ Indirect PAR measurements for biological studies

Specifications:

Spectral Response: 300 nm to 1100 nm

Illuminance Range: 0 to 131,000 lux

Irradiance Range: 0 to 1362 W/m²

PAR Range: 0 to 2400 μmol/m²/s

UV Index Range: 0 to 12 (typical in daylight)

RGB and White Light Range: 0 to 100%

Maximum Sample Rate: 2 Hz (ambient); 20 Hz (spot)

Battery: Coin cell

Connectivity: Bluetooth 4.0

Logging: Yes

Order Information

Wireless Hand-Grip Heart Rate SensorPS-3206

Order Information

Wireless Light SensorPS-3213

Wireless Light Sensor Pack.....PS-3338



Wireless Load Cell and Accelerometer

PS-3216

The Wireless Load Cell and Accelerometer is designed to measure loads in all PASCO Structures Systems. It is particularly useful for measuring vibrations because it includes an accelerometer and has no wires to impede movement.

Specifications:

- Load Cell Range:** ± 50 N
- Load Cell Resolution:** 0.03 N
- Load Cell Accuracy:** 0.1 N
- Load Cell Maximum Sample Rate:** 2 kHz
- Acceleration Range:** ± 16 g (three-axis)
- Acceleration Maximum Sample Rate:** 500 Hz
- Measurements:** Force; Acceleration (3 axes and resultant)
- Logging:** Yes
- Battery:** Rechargeable Lithium-Polymer
- Connectivity:** Direct USB or via Bluetooth 4.0

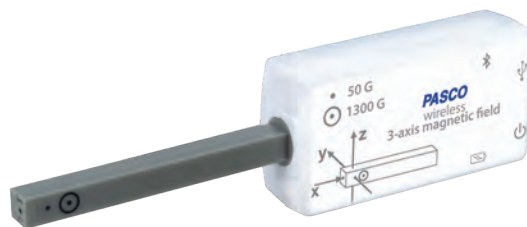
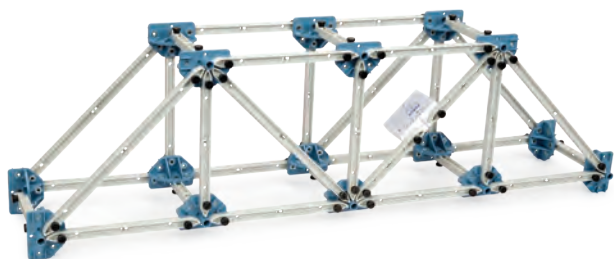

Wireless Magnetic Field Sensor

PS-3221

This 3-Axis Magnetic Field Sensor can sense the Earth's magnetic field, magnetic fields from current-carrying coils, and permanent magnets. There are two ranges: ± 50 gauss and ± 1300 gauss. This sensor is primarily for static fields.

Highlights:

- Simultaneous measurements on three axes
 - Dual range: ± 50 G and ± 1300 G
 - Sensitive enough to measure the Earth's magnetic field
- Measure fields from permanent magnets and current-carrying coils

Specifications:

- Ranges:** ± 50 G and ± 1300 G
- Resolution:** ± 0.01 G (50 G range); ± 1 G (1300 G range)
- Maximum Sample Rate:** 100 Hz
- Measurements:** Magnetic Field Strength (3 axes and resultant)
- Logging:** Yes
- Battery:** Rechargeable Lithium Polymer
- Connectivity:** Direct USB or via Bluetooth 4.0

Applications:

- ▶ Measure magnetic field of permanent magnets
- ▶ Measure Earth's magnetic field
- ▶ Measure field strength of Helmholtz coils

Includes:

- 3-Axis Magnetic Field Sensor
- Sensor Mounting Rod
- USB Charging Cable

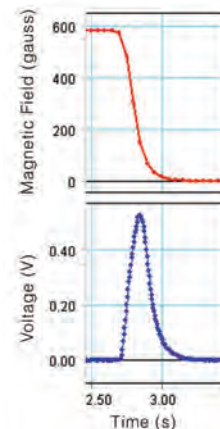

Order Information

Wireless Load Cell and AccelerometerPS-3216

Order Information

Wireless Magnetic Field SensorPS-3221



Wireless Motion Sensor

PS-3219

The Wireless Motion Sensor connects via Bluetooth or USB to your device, and uses ultrasound to measure the position, velocity, and acceleration of objects. This enables students to take turns measuring themselves, while the class observes their motion materializing as a graph in real time. The sensor can detect objects ranging from 15 cm to 4.0 m away, and without cables to get in the way, students can explore handheld and ceiling-mounted applications.

Features:

- ▶ Measures position, velocity, and acceleration
- ▶ False Target Rejection Technology produces cleaner data
- ▶ Clips directly to PASCO Dynamics Tracks
- ▶ Rod clamp for mounting
- ▶ 180° pivoting head
- ▶ Rechargeable Lithium-ion battery
- ▶ Bluetooth® or USB connectivity

Specifications:

Range: 0.15 to 4 m

Resolution: 1 mm

Maximum Sample Rate: 100 Hz

Transducer Rotation Range: 180°

Battery: Rechargeable Lithium-polymer

Connectivity: Direct USB or via Bluetooth (Bluetooth 4.0)

Logging: Yes

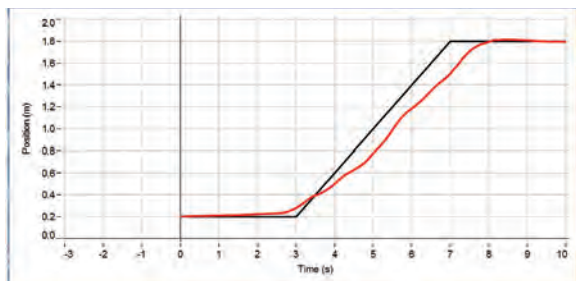

Order Information

Wireless Motion SensorPS-3219

Wireless Motion Sensor PackPS-3337



Wireless Optical Dissolved Oxygen Sensor

PS-3224

The Wireless Optical Dissolved Oxygen (ODO) Sensor is ideal for monitoring DO₂ in the lab or field. The Wireless Optical DO Sensor contains three different sensors. In addition to the dissolved oxygen sensor, it also includes sensors for measuring atmospheric pressure and water temperature. The optical technology is accurate, fast, and does not require stirring, filling solutions, warm-up, or frequent calibration. When equipped with the included cover, the sensor has a waterproof design and is submersible to a depth of 10 m.

A PASCO exclusive feature allows you to log data using the sensor's built-in memory. After collecting data for hours or even days, simply connect the sensor to your device and you're ready to download your data. With this powerful sensor, educators can explore day and night nutrient cycles, changes in metabolic processes, seasonal changes in water quality, and more.

Applications:

- ▶ Teaching field sampling techniques
- ▶ Exploring how temperature influences dissolved oxygen concentrations
- ▶ Measuring net primary productivity
- ▶ Modeling ecosystems
- ▶ Monitoring water quality and investigating watersheds
- ▶ Investigating photosynthesis and cellular respiration in aquatic environments

Specifications:

Dissolved Oxygen Range: 0 to 20 mg/L, 0 to 300% saturation

Accuracy - with user calibration: ±0.2 mg/L or 1% (whichever is greater)

Accuracy - out of the box: ±0.5 mg/L or 3% (whichever is greater)

Response Time: 90% in 45 sec

Measurements: Concentration (mg/L), Saturation (%), O₂ Gas (in air, qualitative) (%), Temperature (°C)

Waterproof Depth: 10 m (30 ft)

Logging: Yes

Order Information

Wireless Optical Dissolved Oxygen SensorPS-3224



Wireless Oxygen Gas Sensor

PS-3217

The Wireless Oxygen Gas Sensor measures gaseous O₂ concentration as well as humidity and air temperature for a range of biology, environmental science, and physiology activities.

The Wireless Oxygen Gas Sensor is accurate and easy to use, making it the perfect sensor to study photosynthesis, respiration, and oxygen cycling in the environment. With remote logging, experiments can go beyond the lab period and easily give students hours or days of data for analysis. The Wireless Oxygen Gas Sensor also contains sensors to measure ambient temperature and humidity as well as oxygen gas levels.

Features:

- ▶ Bluetooth® and USB connectivity
- ▶ 0-100% Oxygen gas concentration
- ▶ ±1% Oxygen at constant temperature and pressure
- ▶ Also reports ambient temperature and humidity
- ▶ 2-3 year operating life with replaceable sensing element

Specifications:

Range: 0 to 100% O₂ concentration; 0 to 1,000,000 ppm

Resolution: 0.01% oxygen

Repeatability: 0.5% oxygen

Accuracy: ±1% O₂ at constant temp and pressure; ±5% O₂ outside operating range

Operating Temps: 0 - 40 °C

Relative Humidity Range: 0 - 100% non condensing

Sensing Element Lifespan: 2+ years

Logging: Yes

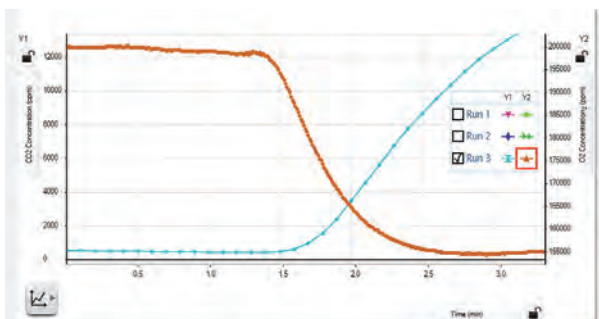

Order Information

Wireless Oxygen Gas Sensor.....PS-3217

Wireless pH Sensor

PS-3204

The Wireless pH Sensor is a must-have for any chemistry, biology, or environmental science course. Equally capable in the lab or field, the sensor eliminates the hassle of cables, reducing spills and improving safety. Plus, it rarely requires charging; the sensor's coin cell battery lasts for 2-3 years in most labs and costs about one dollar to replace. It can transmit data in real time, or store data for days when continuous monitoring is required. The Wireless pH Sensor enhances countless activities, including acid-base titrations, investigations into household chemicals, analyses of chemical reactions, water quality studies, and much more.

Features:

- ▶ Simply pair and go, no cables or interfaces to manage
- ▶ Compatible with ion-selective electrodes (ISE) and the oxidation reduction probe (ORP)
- ▶ Features Bluetooth® wireless connectivity and a long-lasting coin cell battery
- ▶ Logs pH data directly onto the sensor for long-term experiments
- ▶ Wireless connection to SPARKvue and Capstone for intuitive analysis and lab reports

Perform These Experiments:

- ▶ Monitor pH during chemical reactions
- ▶ Investigate household chemicals
- ▶ Explore acid-base titrations
- ▶ Investigate the chemistry of buffers
- ▶ Measure pH for water quality studies

Specifications:

Range: 0-14 pH

Resolution: 0.02 pH

Accuracy: ±0.1 pH with calibration

Connectivity: Bluetooth 4.0

Temperature Range: 5°C to 60°C

Logging: Yes

Order Information

Wireless pH Sensor.....PS-3204

Wireless pH Sensor PackPS-3331



Polarimeter

PS-3237

PASCO's Polarimeter has both Bluetooth® and USB connectivity, so it works on your iPad®, Chromebook™, tablets, and computers. It is ideal for introductory Organic and Biochemistry experiments with chiral compounds.

Polarimeters pass plane polarized light through a sample, which contains a chiral compound, and then through an analyzer and a detector. The degree of optical rotation of the plane polarized light is based on the concentration of sample present.

Applications:

- ▶ Determine the concentration of a sugar solution based on the optical rotation of plane polarized light.
- ▶ Explore simple sugar families by assigning unknowns and having students determine which family they have.
- ▶ Differentiate between common chiral and non-chiral compounds.
- ▶ Calculate a racemic mixture's purity.

Specifications:

Connectivity: Bluetooth and USB

LED light source: 589 nm

Optical Rotation Accuracy: $\pm 0.09^\circ$

Cell Length (horizontal): 101 mm \pm 0.6 mm

Logging: No

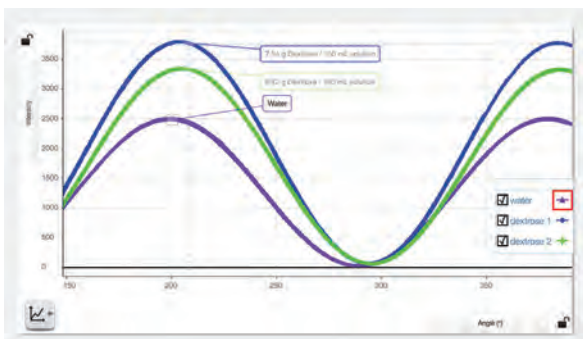

Optical rotation of Dextrose

Order Information

Wireless PolarimeterPS-3237



Wireless Pressure Sensor

PS-3203

The Wireless Pressure Sensor allows students to easily collect accurate gas pressure data for a wide range of applications. Included is a 60-cc syringe, tubing, and connectors that facilitate experiments such as Boyle's Law, measuring pinch-grip strength and measuring hydrostatic pressure in water. Within PASCO's software, students can easily select their desired units from a list containing kPa, mmHg, inHg, mbar, psi, atm, and torr.

Features:

- ▶ Measures pressure even when the pressure within the system drops below ambient pressure.
- ▶ Supports common units (kPa, atm, psi, mmHg, or N/m²) for many applications.
- ▶ Features Bluetooth® wireless connectivity and long-lasting rechargeable battery.

Perform These Experiments:

- ▶ Study Boyle's Law and Charles' Law
- ▶ Investigate pinch-grip strength and muscle fatigue
- ▶ Monitor plant transpiration when setup as a potometer
- ▶ Study enzyme reactions using hydrogen peroxide and catalase

Specifications:

Range: 0-400 kPa

Resolution: 0.1 kPa

Accuracy: ± 2 kPa

Max sample rate: 1000 Hz

Connectivity: Bluetooth 4.0

Logging: Yes

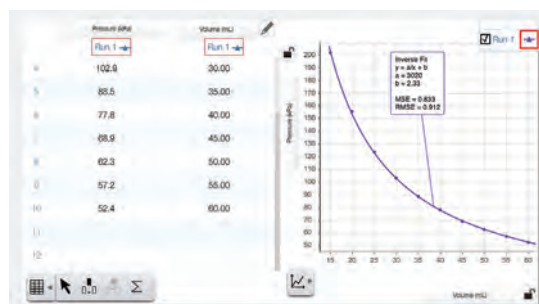

Order Information

Wireless Pressure SensorPS-3203
Wireless Pressure Sensor PackPS-3333



Wireless Rotary Motion Sensor

PS-3220

The Wireless Rotary Motion Sensor measures angle, angular velocity, and angular acceleration, as well as their linear equivalents. The included three-step pulley allows different torques to be applied, rotating a rigid system at different rates of acceleration. The included rod-mounting holes let you orient the sensor for different experiments. The Wireless Rotary Motion Sensor connects directly to your devices via Bluetooth or USB.

Applications:

- ▶ Conservation of Angular Momentum
- ▶ Rotational Inertia
- ▶ Centripetal Acceleration
- ▶ Torque

Specifications:

Angle resolution: 0.18° (0.00314 radian)

Linear resolution: 0.0157 mm (with 5 mm pulley radius)

Three-step pulley: 10, 29, and 48 mm diameter

Shaft diameter: 6.35 mm

Maximum rotation rate: 30 revolutions per second

Optical encoder: 2000 divisions/rev, bidirectional

Rechargeable battery: Lithium polymer

Connectivity: Direct USB or via Bluetooth 4.0

Logging: Yes

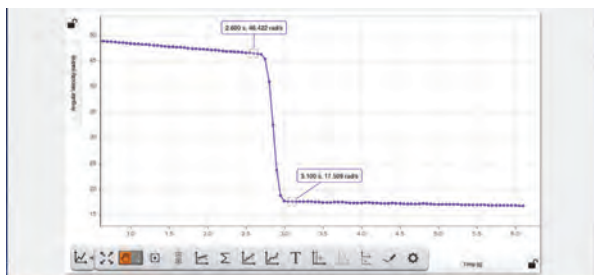

Show that angular momentum is conserved: The Wireless Rotary Motion Sensor records the angular velocity as a ring is dropped on a spinning disk.

Order Information

Wireless Rotary Motion SensorPS-3220



Wireless Smart Gate

PS-3225

The Wireless Smart Gate has all the features of the wired Smart Gate. It has dual photogate beams spaced at 1.5 cm to accurately measure speed and velocity. The built-in laser switch (when used with any laser) allows you to time objects too large to fit through the arms of the Smart Gate. The integrated slot on the arm of the Smart Gate receives photogate tape that also helps measure the movement of larger and faster objects, like model rockets. The auxiliary port is for adding an additional photogate head or Time-of-Flight Accessory.

Highlights:

- Dual photogate beams
- Laser switch
- Photogate tape slot
- Auxiliary photogate/Time-of-Flight port
- USB and Bluetooth®
- Rechargeable

Specifications:

Battery: Rechargeable Lithium Polymer

Connectivity: Direct USB or via Bluetooth 4.0

Logging: No

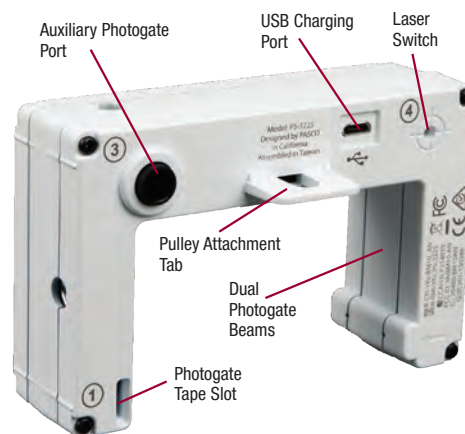

Order Information

Wireless Smart GatePS-3225



Smart Cart (Red & Blue)

ME-1240/ME-1241

The patented Smart Cart is the ultimate tool for studying kinematics, dynamics, Newton's Laws, and more. It is based on a durable ABS body with nearly frictionless wheels, just like our high quality PAScars. Now, we've added built-in sensors that measure force, position, velocity, and acceleration. The versatile Smart Cart can collect measurements on or off a track and transmit the data wirelessly over Bluetooth. In essence, it is a wireless dynamics cart that combines all the necessary sensors, without requiring any additional hardware.

Smart Carts are ideal for studying mechanics topics, such as kinematics and dynamics. The built-in load cells enable two Smart Carts to visually demonstrate Newton's Third Law with ease. Additionally, built-in sensors for force and acceleration enable students to investigate Newton's Second Law in minutes. Smart Carts truly are a physics lab on wheels, and now you can own the most advanced physics cart ever created, all without the restrictions of cables.

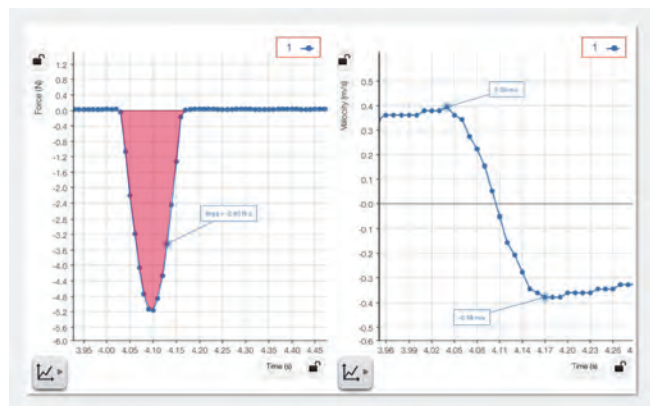

The graphs show the impulse experienced and the change in velocity created by a collision between a Wireless Smart Cart and a cardboard bumper.



Features:

- ▶ Built-in ± 100 N force sensor
- ▶ 3-axis accelerometer
- ▶ Bluetooth® connectivity
- ▶ Rechargeable battery
- ▶ Motion encoder measures position and velocity on or off the track
- ▶ Magnetic bumper for force sensor
- ▶ 3-position plunger
- ▶ Mass tray
- ▶ Velcro® tabs
- ▶ Force sensor hook and rubber bumper

Specifications:

- Force Range:** ± 100 N
- Force Resolution:** 0.1 N
- Force Accuracy:** $\pm 1.0\%$
- Force Maximum Sampling Rate:** 2.0 kHz
- Position Resolution:** ± 0.2 mm
- Max Velocity:** ± 3.0 m/s
- Velocity Max Sample Rate:** 500 Hz
- Acceleration Range:** ± 16 g
- Acceleration Max Sample Rate:** 500 samples/second
- Max Rotational Speed Sampling Rate:** 500 samples/second
- Max Wireless Range:** 30 m (unobstructed)
- Maximum Measurable Rotation Rate (Gyro):** ± 245 deg/second
- Mass Without Accessories:** 245 g
- Patent No.:** 10481173
- Magnetic Bumper Mass:** 23.6 g
- Logging:** No

Smart Cart Charging Garage

ME-1243

Charge up to five Smart Carts at once. Provides storage for the carts and accessory bumpers. Includes power adapter.



Order Information

Smart Cart (Red)	ME-1240
Smart Cart (Blue)	ME-1241
Smart Cart Charging Garage	ME-1243



NEW

Wireless Soil Moisture Sensor

PS-3228

The Wireless Soil Moisture Sensor measures the volumetric water content (%VWC) of soil, reporting data in real time or storing it onboard the sensor's memory for long-term experiments. Durable and easy to use, the Wireless Soil Moisture Sensor is the perfect tool for monitoring controlled experiments in the classroom and long-term experiments outdoors. From experiments in evaporation and soil composition to water consumption and plant competition, the Wireless Soil Moisture Sensor makes it easy for students to investigate a wide array of topics through live or long-term data collection.

To use the sensor, dig a trench a few inches below the ground's surface and place the sensor's spear-shaped portion in the soil. Be sure to pack the soil tightly around the sensor for best accuracy. After use, the surrounding soil should be loosened to reduce the risk of damaging the sensor's cord.

Features:

- ▶ Collect and display data in real time within PASCO Capstone or SPARKvue software
- ▶ Automate data collection for hours, days, or weeks with Logging Mode
- ▶ Bluetooth connectivity enables use in the classroom, lab, or field
- ▶ Supports use of GPS data from a mobile device for GIS mapping activities
- ▶ Selectable calibrations for predominantly sandy soils, clay soils, and loamy soils

Specifications:

Sensor Range: 0 to 45% water by volume

Sensor Accuracy: ±5%

Resolution: 0.1%

Power: 3 mA at 5 V DC

Operating Temperatures: -40 to 60°C

Probe cable length: 2m

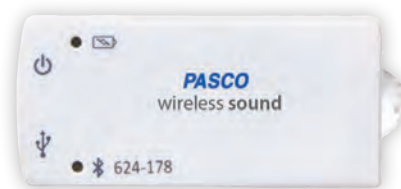

Wireless Sound Sensor

PS-3227

The PS-3227 Wireless Sound Sensor is two sensors in one wireless package: a sound wave sensor capable of measuring relative changes in sound pressure level as a function of time, and a sound level sensor with both dBA and dBC-weighted scales.

Sound Wave Sensor: The Sound Wave Sensor measures relative changes in sound pressure level as sound waves are incident on the sensor. With graphs of the sound wave measurement versus time, students can explore and analyze wave properties like wave shape, wave speed, amplitude, frequency, wavelength, and much more. Students can use this sensor to explore superposition of waves and beat frequencies, while also exploring standing wave harmonics, and the presence of overtones.

Sound Level Sensor: The Sound Level Sensor gives you true sound level (intensity) measurements with both dBA and dBC scales. The dBC weighting scale measures the intensity of sounds in a wide range of frequencies within, and outside the frequency range of human hearing. The dBA weighting scale filters some of the sound frequencies from a sound source to more closely match the frequency response of the human ear. This new sensor gives you a wireless solution to measure sound level with all the capability of a sound level meter, but adds the flexibility of recording data continuously as a function of time.

Features:

- ▶ Wireless and portable
- ▶ Measure sound wave data at high sample rates (100 kHz)
- ▶ Two sound sensors in one (sound wave and sound level)
- ▶ High quality sensing element intended specifically for laboratory experiments
- ▶ Connects seamlessly to Scope and FFT displays in both SPARKvue and PASCO Capstone software
- ▶ Threaded 1/4-20 socket for easy mounting and alignment/positioning

Specifications:

Microphone Frequency Range: 100 – 15,000 Hz

Sound Wave Maximum Sampling Rate: 100 kHz

Sound Level Range: 50 - 110 dB

Accuracy: ±2 dB

Response: A or C weighted

Logging: Yes

Order Information

Wireless Soil Moisture Sensor.....PS-3228

Order Information

Wireless Sound Sensor.....PS-3227

Wireless Sound Sensor Pack.....PS-3342



SPARK LXi2 Datalogger

PS-3600B

The SPARK LXi2 Datalogger is a Bluetooth, handheld datalogger that enables students to connect wired and wireless sensors, collect data, generate graphs, and analyze results. It is durable, splash-proof, and works seamlessly with PASCO sensors. The SPARK LXi2 can simultaneously accommodate up to five wireless sensors, includes two ports for PASPORT sensors, as well as two ports for the included Fast Response Temperature Probe and Voltage Probe. It can be used with PASCO Wireless sensors, PASPORT sensors, SPARKlink® Air, and the 550 Universal Interface.

Built for Student Use:

- ▶ Portable
- ▶ Shock-absorbing case
- ▶ 8" Color Capacitive Touchscreen (1280 x 800 pixels)
- ▶ 2.0 GHz Quad Core Processor, 2.0 GB RAM, 32 GB Memory
- ▶ Voltage and temperature sensor ports with included probes
- ▶ Wi-Fi enabled
- ▶ Wireless sensors and Smart Carts connect via Bluetooth®
- ▶ AirLink, SPARKlink Air, or 550 Universal Interface via USB or Bluetooth
- ▶ Two PASPORT sensor ports
- ▶ **Loaded with PASCO software:** SPARKvue® for data collection and analysis, MatchGraph!, and Spectrometry

* LXi2 model PS-3600B does not include the Lab Manager application

Specifications:

CPU: Quad Core, 2.0 GHz

Screen: 8.00" color capacitive touchscreen, 1280 x 800 px

Memory: 32 GB Internal, 2.0 GB RAM

Camera: 5.0 MP front camera

WiFi: 802.11

Bluetooth: 5.0 + Classic

PASPORT Sensor Ports: 2

Built-In Sensors: Voltage port w/probe, Temperature port w/Fast Response Temp probe



Front view of the SPARK LXi2

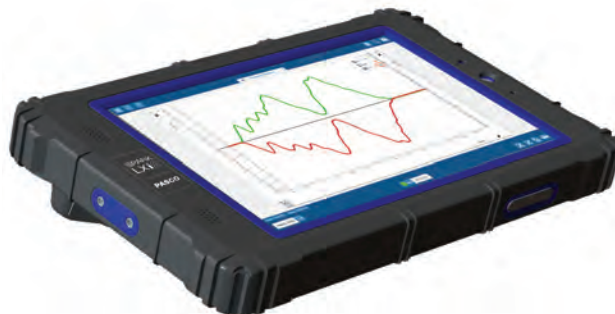

Perspective view of the SPARK LXi2



The SPARK LXi2 features two PASPORT ports as well as ports for the included temperature and voltage probes.



Scan to learn more about the SPARK LXi2

Order Information

SPARK LXi2.....PS-3600B



SPARKlink Air Interface

PS-2011

The SPARKlink® Air allows students and teachers to connect any of our 70+ PASPORT sensors to their device via USB or Bluetooth®. This device allows students to collect data using a desktop or laptop running SPARKvue or PASCO Capstone software, or with a Bluetooth iOS or Android device running the SPARKvue app.

Features:

- ▶ Includes a Fast Response Temperature Sensor and Voltage Sensor
- ▶ Connects via Bluetooth to Mac, Windows, iOS, and Android devices. (Bluetooth not supported on Chromebooks)
- ▶ Connects via USB to Mac or Windows computers and Chromebooks
- ▶ Rechargeable battery provides 4 to 6 hours of continuous data collection between charges
- ▶ Mobile design allows students to explore science inside and outside the classroom

Includes:

- AC Adapter
- USB Cable
- Fast Response Temperature Probe
- Voltage Probe

Specifications:

Interface Type: USB or Bluetooth 2.0 (classic)

Ports: 4 (2 PASPORT, 1 Voltage, 1 Temperature)

AirLink Interface

PS-3200

The Airlink connects PASPORT sensors to a Mac or Windows computer, Chromebook, iPad, tablet, or smartphone via Bluetooth or USB connection. The USB cable is included.



Wireless Spectrometer (VIS)

PS-2600

The Wireless Spectrometer from PASCO is specifically designed for modern chemistry, biology, and physics labs. With Bluetooth and USB connectivity, students can quickly connect from their device or computer using the free PASCO Spectrometry Software. With this affordable spectrometer, students can gather a full spectrum of data in under one second. After specifying a target wavelength, students can study concentrations (Beer's Law), rates of reactions, or investigate emission spectra using the optional fiber optic cable.

Applications:

- ▶ Photosynthesis with DPIP
- ▶ Absorption spectra of plant pigments
- ▶ Concentration of proteins in solution
- ▶ Rate of an enzyme-catalyzed reaction
- ▶ Growth of a cell culture
- ▶ Absorption spectrum of chlorophyll
- ▶ Emission spectra of light from flame tests or other sources
- ▶ Easily identify peak wavelengths for concentration data
- ▶ Study the relationship between concentration and absorbance (Beer's Law)
- ▶ Reaction Kinetics

Specifications:

Resolution: 2–3 nm FWHM

Detection Range: 380–950 nm

Fluorescence Excitation Wavelengths: 405 nm and 500 nm

Light Source: LED-boosted tungsten

Connectivity: USB or Bluetooth 2.0 (classic)

Logging: No

Order Information

SPARKlink Air InterfacePS-2011

AirLink InterfacePS-3200

Order Information

Wireless Spectrometer (VIS).....PS-2600



Wireless Spirometer



PS-3234

New: The Wireless Spirometer Sensor makes it safe and easy for students to collect respiratory measurements, including flow rate, pressure, and lung volume. Ideal for studies in health and human physiology, the Wireless Spirometer Sensor streamlines experiments by providing students with real-time data, interactive graphs, and analysis tools on virtually any device. The disposable mouthpieces are designed for use with a single student and feature exchangeable filters that protect the sensor from particulates to ensure long-term hygienic use. Additional mouthpieces are available in convenient packs of ten.

Educational Use Only: This is not a medical device. PASCO products are designed for educational use only and should not be used in any apparatus involved with life support, medical testing, patient diagnosis, or industrial control/testing systems.

The PASCO Wireless Spirometer allows students to determine the volume of gas that passes through a tube during expiration, their total lung volume, and the factors that can affect it. Students can also estimate the amount of oxygen in their bloodstreams and the overall oxygen efficiency of their lungs by integrating data from a PASCO Wireless Oxygen or CO₂ Sensor.

Specifications:

Low Setting Range: ±5 V

High Setting Range: ±15 V

Resolution: 2 mV (±5 V range); 7 mV (±15 V range)

Accuracy: ±1.0%

Maximum Sampling Rate (Bluetooth): 1000 Hz

Maximum Sampling Rate (USB): 100 kHz

Product Input Resistance: >1.0 MΩ

Logging: Yes

Order Information	
Wireless Spirometer.....	PS-3234
Spirometer Mouth Piece Replacements (10).....	PS-2522
Spirometer Mouth Piece & Pre-Filter	PS-3245



Wireless Temperature Sensor



PS-3201

Welcome to the modern thermometer. The Wireless Temperature Sensor transmits live data and allows students to continuously monitor, log, and plot temperature measurements on nearly any device. When lab-time ends but the experiment continues, students can set the sensor to log data autonomously for days, weeks, or months, then download it for analysis later. This durable, wireless sensor features a stainless steel probe for the most demanding of applications, as well as a battery that lasts over a year*. It can be used in a wide array of experiments and activities because it measures small, but significant temperature changes produced by chemical reactions, convection currents, and even skin temperatures.

Specifications:

Range: -40°C to 125°C

Resolution: 0.01°C

Accuracy: 0.5°C

Connectivity: Bluetooth 4.0

Logging: Yes



Wireless Temperature Sensor Link



PS-3222

The Wireless Temperature Sensor Link enables wireless connection for any PASCO temperature probe with a 3.5-mm connection. The link comes with a Fast Response Temperature Probe, but it can also connect to the Stainless Steel Temperature Probe, Skin/Surface Temperature Probe, the Absolute Zero Sphere, and the Ideal Gas Law Apparatus.

Specifications:

Battery life: >1 year

Compatible Temperature Probes: Skin/Surface (PS-2131); Fast Response (PS-2135); Stainless Steel (PS-2153)

Range with Included Probe: -30°C to 105°C

Jack: 3.5 mm stereo

Connectivity: Bluetooth 4.0

Logging: Yes

Includes:

- Fast Response Temperature Probe

Order Information	
Wireless Temperature Sensor.....	PS-3201
Wireless Temperature Sensor Pack	PS-3330
Wireless Temperature Sensor Link	PS-3222



Wireless Voltage Sensor

PS-3211

The Wireless Voltage Sensor is ideal for exploring the fundamental concepts of electricity, voltage, and basic circuits. It measures voltages up to ± 15 V with built-in overload protection, and features high-speed sampling rates when used with a USB connection. When combined with the Wireless Current Sensor, students can use it to explore Ohm's Law, circuits in series and parallel, and much more.

Features:

- ▶ **Two Ranges:** ± 15 V, ± 5 V
- ▶ **Resolution:** 7 mV (± 15 V range); 2 mV (± 5 V range)
- ▶ Bluetooth® sampling rate of 1 kHz
- ▶ Higher speed sampling via USB

Specifications:

- Low Setting Range:** ± 5 V
- High Setting Range:** ± 15 V
- Resolution:** 2 mV (± 5 V range); 7 mV (± 15 V range)
- Accuracy:** $\pm 1.0\%$
- Maximum Sampling Rate:** 100 kHz
- Input Resistance:** >1.0 M Ω

Includes:

- Wireless Voltage Sensor
- USB Cable
- Red, Banana-to-alligator-clip
- Black, Banana-to-alligator-clip



Wireless Weather Sensor with GPS

PS-3209

The Wireless Weather Sensor is an all-in-one instrument for monitoring complex environmental conditions. It houses several sensing elements within a single unit to provide 19 different measurements. Use the sensor in logging mode with the Weather Vane Accessory for long-term monitoring, or use it as a handheld instrument to study microclimates and record ambient conditions relevant to environmental phenomena. You can even transmit data wirelessly to your device for classroom analysis when group activities are constrained by time. With the built-in GPS, you can also collect location data for student investigations and analyze it on the map display, powered by ESRI ArcGIS, within SPARKvue software.

Specifications:

- Water-resistant:** Splash proof & designed to withstand the elements
- Barometric Pressure Range:** 225 to 825 mm Hg
- Barometric Pressure Accuracy:** ± 0.1 mmHg
- Barometric Pressure Resolution:** 0.02 mmHg
- Ambient Temperature Range:** -40 to 125 °C
- Ambient Temperature Accuracy:** ± 0.2 °C
- Ambient Temperature Resolution:** 0.1 °C
- Wind Speed Range:** 0.5 to 15 m/s (winds of up to ~ 33 mph)
- Wind Speed Accuracy:** 3% of reading
- Wind Speed Resolution:** 0.1 m/s
- Relative Humidity Range:** 0 - 100%
- Relative Humidity Accuracy:** $\pm 2\%$
- Relative Humidity Resolution:** 0.1%
- Illuminance* (Light Level) Range:** 0 to 130,000 lux
- PAR Range (Based on Solar Radiance):** 0 to 2400 $\mu\text{mol}/\text{m}^2/\text{s}$
- Irradiance Range (Based on Solar Radiance):** 0 to 1362 W/m^2
- UV Index Range:** 1 to 12
- UV Index Accuracy:** ± 1
- UV Index Resolution:** 1
- Altitude (via GPS) Range:** 0 to 18,000 m
- Altitude (via GPS) Accuracy:** 2.5 (50% CEP)
- Altitude (via GPS) Resolution:** 0.5 m
- Speed (via GPS) Range:** 0 to 515 m/s
- Speed (via GPS) Accuracy:** 0.05 m/s
- Speed (via GPS) Resolution:** 0.05 m/s
- Operating Environment (Temperature):** -20 to 150 °C
- Operating Environment (Max Wind Speed):** 65 mph
- GPS Channels:** 66
- GPS Warm Up Time:** 35 seconds or less
- UV Index Range:** 1 to 12
- Logging:** Yes

Order Information

- Wireless Voltage Sensor.....PS-3211
- Wireless Voltage Sensor PackPS-3335

Order Information

- Wireless Weather Sensor with GPSPS-3209
- Wireless Weather Sensor with GPS Pack.....PS-3340

Sensor & Interface Index

	Part Number	Page Number
PASPORT (BLUE) SENSORS		
AirLink Interface.....	PS-3200	128
Breath Rate	PS-2187	129
Charge.....	PS-2132	129
Displacement.....	PS-2204	129
EKG	PS-2111	130
Ethanol.....	PS-2194	130
Flow Rate/Temperature	PS-2130	130
Force.....	PS-2104	131
Force (High Resolution).....	PS-2189	131
Force Platform	PS-2141	131
Force Platform (2-axis).....	PS-2142	132
Galvanometer	PS-2160	132
General Science	PS-2168	132
Goniometer	PS-2137	133
Light (Broad Spectrum).....	PS-2150	133
Light (High Sensitivity).....	PS-2176	133
Light (Infrared).....	PS-2148	134
Load Cells and Amplifiers.....	various	134
Magnetic Field	PS-2112	134
Magnetic Field (2-Axis).....	PS-2162	135
Motion.....	PS-2103A	135
Motion (Rotary)	PS-2120A	135
Photogate and Accessories.....	various	136
Pressure (Dual).....	PS-2181	140
Radiation (Alpha Beta Gamma).....	PS-2166	137
Salinity	PS-2195	137
Smart Gate	PS-2180	136
Soil Moisture.....	PS-2163	137
Spirometer	PS-2152	138
Temperature (Fast Response).....	PS-2135	138
Temperature (Skin/Surface)	PS-2131	138
Temperature (Stainless Steel)	PS-2153	139
Temperature (Non-Contact).....	PS-2197	139
Thermocline	PS-2151	139
Time-of-Flight.....	ME-6810A	136
Water Quality Colorimeter.....	PS-2179	140
Electrodes (various).....	ME-6810A	140
Adapters		
Analog Adapter.....	PS-2158	141
Digital Adapter	PS-2159	141
Interfaces		
SPARK LXi2.....	PS-3600A	124
SPARKlink Air	PS-2011	125
Universal Interface, 550.....	UI-5001	102
Storage		
Storage Trays, Rolling Carts	various	142-143



AirLink Interface

PS-3200

The AirLink Interface connects PASPORT sensors to a Mac or Windows computer, Chromebook, iPad, tablet, or smartphone via Bluetooth or USB connection. The USB cable is included for charging ideally through a usb charging block and data connection to your computer.

Specifications:

Bluetooth: 4.0

Bluetooth Range: 30 m (unobstructed)

Approximate Mass: 59 g

Includes:

- USB cable



Order Information

AirLink InterfacePS-3200



PASPORT Breath Rate Sensor

PS-2187

The Breath Rate Sensor measures breath rate by sensing the pressure change within a standard, disposable dust mask. It generates consistently stable output, even when used during exercise. The sensor's tubing connects to the disposable pressure clips that fasten to the sides of the mask.

Two modes:

- One reading every breath
- Running average over last four breaths

Replacement Accessories:

- ▶ Breath Rate Sensor Disposable Masks (10 pack)
PS-2567
- ▶ Breath Rate Sensor Clips (10 pack)
PS-2568

Includes:

- Sensor with Tubing
- Pressure Clips
- Masks

How It Works:

The Breath Rate Sensor measures breathing rate before, during, and after exercise. Measurements are digitally sent to a computer or datalogger, where they're displayed and recorded for analysis. The sensor detects each breath by monitoring changes in air pressure within a mask worn by the subject. It measures the time between exhalations to determine breath rate. This sensor outputs measurements for breath rate and average breath rate.

Highlights:

- Works while exercising



PASPORT Charge Sensor

PS-2132

The Charge Sensor is designed for experiments in electrostatics such as inductive charging, charge production/distribution, and charge on a capacitor. The sensor features automatic scaling, eliminating the need for a gain switch. Designed with highly efficient input over-voltage protection, the Charge Sensor is virtually "blow-out" proof and will provide many years of use in the student lab.

When used with the Faraday Ice Pail, the Charge Sensor can measure the total charge on an object by the induction method.

The Charge Sensor can also be used as a high impedance voltmeter ($10^{12} \Omega$). It includes a 0.9 m shielded cable with alligator clips to eliminate stray fields.

Features:

- ▶ Measures both charge and voltage.
- ▶ No guessing if a charge is positive or negative – the polarity is shown.
- ▶ **Includes a 0.9m shielded cable with alligator clips:** eliminate stray fields for quick experiment setup.

Specifications:

Charge Range: $\pm 0.1 \mu\text{C}$

Voltage Range: $\pm 10 \text{ V}$

Input Resistance: $10^{12} \Omega$

Maximum Input Voltage: 150 V

Maximum Sample Rate: 100 Hz

Input Connector: BNC

Input Cable: 0.9 m length; shielded with alligator termination



PASPORT Displacement Sensor

PS-2204

The Displacement Sensor measures the travel of a spring-loaded indicator as a bridge is loaded with weight. The included PASPORT Sensor plugs into the included Digital Indicator, which includes its own digital LED readout and can be used as a standalone device. To record your data, simply plug the PASPORT sensor into an interface.

Features:

- ▶ Digital Gauge includes LED display with live readings
- ▶ Data can be downloaded from the PASPORT Sensor using an interface
- ▶ Digital Indicator can be used as a standalone device

Specifications:

Maximum Travel: 10 mm

Maximum Sample Rate: 5 Hz

Resolution: 0.013 mm (0.0005 in)

Includes:

- Sensor
- Bracket
- Dial Gauge

Specifications:

Maximum Travel: 10 mm

Maximum Sample Rate: 5 Hz

Resolution: 0.013 mm (0.0005 in)

Order Information

PASPORT Breath Rate SensorPS-2187

Order Information

PASPORT Charge Sensor.....PS-2132

Order Information

PASPORT Displacement Sensor.....PS-2204



PASPORT EKG Sensor

PS-2111

The EKG Sensor measures electrical signals produced by the heart. As cardiac muscle depolarization and repolarization occur, the EKG trace graphically illustrates the beating of the heart. The sensor comes with 100 self-adhesive conductive patches that are easily removed from the skin after use.

Features:

- ▶ Standard three-electrode design
- ▶ Easy-to-use, disposable stick-on electrodes
- ▶ No messy gel required
- ▶ Great for stimulus response reflex studies

Applications:

- ▶ Generate a personal EKG graph
- ▶ Compare EKG graphs before and after mild exercise

Replacement Accessories:

- ▶ EKG Sensor Electrode Patches CI-6620

Includes:

- 100 self-adhesive disposable electrode patches

Specifications:

Waveform Voltage: 0 to 4.5 mV

Waveform Resolution: 4.5 μ V

Waveform Sample Rate: 50 to 200 samples per second (sps)

Waveform Default Sample Rate: 200 sps

Heart Rate (Beats) Range: 47 to 250 beats per minute (bpm)

Heart Rate (Beats) Resolution: 1 bpm



PASPORT Ethanol Sensor

PS-2194

The PASPORT Ethanol Sensor measures the concentration of gaseous ethanol up to 3%. In biology and environmental science labs, students can learn about anaerobic respiration by measuring the production of ethanol by bacterial or yeast fermentation. Physics and chemistry students can begin to explore combustion and thermodynamics. Connect your students to the study of respiration and alternative energy sources with the PASPORT Ethanol Sensor.

Note: This is a gas sensor - it should not be submerged into liquids. If exposed to gases with ethanol concentrations above the recommended maximum of 3% the sensor element will be depleted.

Applications:

- ▶ Monitor yeast activity by monitoring ethanol production at different temperatures, with different concentrations of sugar, or with different types of sugars.

Includes:

- Probe
- Sensor electronics amplifier
- PTFE tape for membranes

Specifications:

Accuracy: 20% of reading

Range: 0% to 3% gaseous ethanol



PASPORT Flow Rate/ Temperature Sensor

PS-2130

PASCO's Flow Rate Sensor allows students to measure the temperature and the rate of movement of streams, rivers, and other flowing systems. The propeller is a rugged, single-piece unit encased by protective material, so you'll never have to worry about losing pieces at the bottom of the stream.

Features:

- ▶ Telescoping handle reaches deep levels
- ▶ Revolutions of a magnet on the submersible impeller are counted and converted to linear flow rate measurements in ft/s or m/s
- ▶ Students can use Capstone or SPARKvue software to calculate volume discharge rates.
- ▶ Exclusive built-in temperature sensor conveniently measures temperature at the same point as flow rate

Specifications:

Flow Range: 0 m/s to 3.5 m/s

Accuracy: 0.1 ft/s

Pulse Frequency: 8.62 pulse/linear foot

Unit options: meter/sec; feet/sec; total pulses

Probe Length: 3 to 7 ft. with telescoping tube (Probe is 7 ft when fully expanded)

Temperature Range: -10°C to 50°C

Maximum Length: 1.8 m (6 feet)

Maximum Sample Rate: 20 Hz

Order Information

PASPORT EKG SensorPS-2111

Order Information

PASPORT Ethanol SensorPS-2194

Order Information

PASPORT Flow Rate/TempPS-2130



PASPORT Force Sensor

PS-2104

The study of force is critical to many science explorations. This accurate and rugged sensor will ensure your students get the most out of their force experiments. Pull and push forces up to ± 50 N are measured in one dimension. A simple ZERO button on the top of the sensor enables quick and easy restarts, eliminating the need for confusing data manipulations. The sensor includes an overload stop in the force beam and a polycarbonate, plastic case to protect it from damage. Finger holes are provided for handheld use, but the sensor can also be mounted directly to a PASCO Dynamics Cart or a 0.5" rod stand.

Looking for a wireless option? Check out our Wireless Force Acceleration Sensor (PS-3202).

Features:

- ▶ Easy to zero
- ▶ Force overload protection
- ▶ Includes a receiver and thumbscrew for mounting the sensor to a rod stand
- ▶ High speed sampling for data associated with collisions
- ▶ Minimized side-force measurements
- ▶ Mounts to the top of PASCO dynamics carts

Specifications:

Range: ± 50 N

Resolution: 0.03 N

Zero (Tare) Function: Push-button

Max Sample Rate: 1000 Hz; 5000 Hz with the 550 and 850 interfaces

Force Overload Protection: Up to 75 N without damage



PASPORT High Resolution Force Sensor

PS-2189

The PASPORT High Resolution Force Sensor offers higher resolution than the PS-2104. It features a variable over-sampling rate that reduces measurement noise at lower sampling rates. The digital design minimizes drift, ensuring that the tare holds for hours. You can use this force sensor as a pan balance for long-term experiments, such as investigating the evaporation of liquids, like alcohol or liquid nitrogen, and the sublimation of dry ice.

Features:

- ▶ 0.002 N resolution
- ▶ Dynamic over-sampling
- ▶ Force overload protection up to 75 N
- ▶ Includes a receiver and thumbscrew for mounting
- ▶ Mounts to PASCO dynamics carts

Includes:

- Bumper Attachment
- Hook Attachment
- Bracket Thumbscrew
- Rod Clamp Thumbscrew

Specifications:

Range: ± 50 N

Measurement Resolution: 0.002 N

Zero (Tare) Function: Push-button

Max Sample Rate: 1000 Hz; 5000 Hz with the 550 and 850 interfaces

Force Overload Protection: Up to 75 N



PASPORT Force Platform

PS-2141

The sturdy, glass-filled nylon platform is supported by four force beams that measure the total force acting on the platform. You can use the Force Platform to measure the static weight of a structure or person, as well as the dynamic, vertical force created when moving or jumping. The platform can be placed on a floor or tabletop to measure vertical force, and mounted to a wall to measure horizontal force.

Features:

- ▶ Large enough for jumping and standing
- ▶ Rugged design
- ▶ Force Overload Protection

Applications:

- Determine hang time
- Measure Impulse
- Measure max Force

Specifications:

Range: -1100 N to +4400 N

Force Overload Protection: up to 6600 N (1500 lb, 1700 N or 375 lb per beam)

Platform Size: 35 cm x 35 cm

Zero (Tare) Function: Push-button

Max Sample Rate: 1000 Hz (2000 Hz with the 850 Interface)

Resolution: 0.1 N

Mass: 4 kg (without handles)

Order Information

PASPORT Force Sensor PS-2104

Order Information

PASPORT High Res Force PS-2189

Order Information

PASPORT Force Platform PS-2141



PASPORT 2-Axis Force Platform

PS-2142

The 2-axis Force Platform has a second plate that rides on rollers on the base force platform to measure the force parallel to the platform. There are a total of five force beams: four corner beams to measure the normal force and a fifth beam to measure the parallel (sideways) force.

Applications:

- ▶ Measure the sideways force during a broad jump
- ▶ Measure the normal and parallel forces on a wall as a ladder leans against the wall
- ▶ Measure the normal and parallel forces as a person walks or runs across the platform
- ▶ Pull an object across the platform and measure the normal and frictional forces

Specifications:

Range: -1100 N to +4400 N (in normal direction), -1100 N to +1100 N (in parallel direction)

Size: 35 cm x 35 cm

Mass: 6.4 kg (without handles)

Zero (Tare) Function: Push-Button Force Overload Protection

Max Sample Rate: 1000 Hz (2000 Hz with the 850 Interface)

Resolution: 0.1 N



PASPORT Galvanometer

PS-2160

The Galvanometer Sensor is designed to measure small voltages with high resolution. Dynamic variable over-sampling greatly reduces the measurement noise at low sampling rates. Shunt resistors are included to allow measurement of current.

Recommended Accessories:

- ▶ Alligator Clip Leads (Set of 10) EM-8634

Includes:

- BNC-to-banana plug cable
- BNC-to-banana jack adapter
- 0.1 Ω and 10 Ω resistors

Specifications:

Voltage Range: ± 2000 mV

Resolution: 0.1 mV

Maximum Sample Rate: 1000 Hz

Input Impedance: 1 M Ω



PASPORT General Science Sensor

PS-2168

Simultaneously measure temperature, light, sound level, and voltage. Great for a variety of general science explorations.

Applications:

- ▶ Monitor environmental noise
- ▶ Measure relative light intensities in daylight
- ▶ Compare light intensity versus distance
- ▶ Study resistance, voltage, and capacitance in circuits
- ▶ Measure rapid temperature changes in the environment

Includes:

- Stainless Steel Temperature Probe
- Voltage Probe

Specifications:

Product Temperature*: -35°C to $+135^{\circ}\text{C}$; $\pm 0.5^{\circ}\text{C}$ *Range is probe dependent.

Light: 0 to 150,000 Lux

Sound Level: 50 to 100 dBA

Voltage: ± 24 V

Voltage Protection: up to 240 V

Maximum Sample Rate: 200 Hz

Order Information

PASPORT 2-Axis Force Platform.....PS-2142

Order Information

PASPORT Galvanometer.....PS-2160

Order Information

PASPORT General Science Sensor.....PS-2168

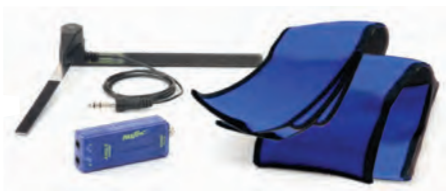

PASPORT Goniometer Sensor

PS-2137

The PASPORT Goniometer Sensor allows students to use their own bodies to contextualize physics. The Goniometer can be connected to knee, hip, or elbow joints to measure angle changes throughout a variety of movements. It can be used to measure the angular position, velocity, and acceleration of an arm or leg. The PS-2137 includes one Angle Sensor (PS-2139) and one Goniometer Probe with a Velcro connection kit. An add-on Goniometer Probe (PS-2138) must be purchased to measure the motion of two joints simultaneously.

Applications:

- ▶ **Angular Motion:** Measure the angular position, velocity and acceleration of an arm or leg.
- ▶ **Tangential Velocity:** Simply enter the correct radius and our software will calculate the linear velocity for any point on an arm or leg.
- ▶ **Torque and Power:** Use with a Force Sensor to measure the power generated by an arm or leg lifting an object. PASCO software can be used to integrate the power vs. time graph to determine energy consumption.

Includes:

- Goniometer Probe
- Angle Sensor
- Velcro Straps

Specifications:

Range: 0 to 340°

Accuracy: $\pm 1^\circ$ (calibrated), $\pm 3^\circ$ (uncalibrated)

Resolution: 0.1°

Maximum Sample Rate: 500 Hz



PASPORT Broad Spectrum Light Sensor

PS-2150

The Broad Spectrum Light Sensor is designed specifically for use with our Educational Spectrophotometer System OS-8539 and Prism Spectrophotometer Accessory OS-8543 for Black Body experiments. The Broad Spectrum Light Sensor uses a thermopile and window combination that respond to both the near infrared and visible light necessary for the Blackbody experiment.

Features:

- ▶ Ideal for Blackbody Spectrum
- ▶ For use with Spectrophotometer

Applications:

- ▶ Blackbody Experiment

Specifications:

Sensing Element: BaF₂ window, xenon gas-filled thermopile

Spectral Response: 300 to 10,000 nm

Maximum Sample Rate: 100 Hz



PASPORT High Sensitivity Light Sensor

PS-2176

The High Sensitivity Light Sensor is designed to perform visible light studies from low intensity spectral studies to daylight. Built-in automatic variable oversampling reduces noise.

Applications:

- ▶ Spectrophotometry
- ▶ Interference and diffraction patterns
- ▶ Measure light intensity vs. distance

Includes:

- PASPORT Sensor Extension Cable
- Sensor Handle

Specifications:

Sensing Element: Si PIN photodiode

Spectral Response: 320 nm to 1100 nm

Gain Levels: 10,000x, 100x, 1x, switch selectable

Approximate Lux Ranges: 0 to 1, 0 to 100, 0 to 10,000

Maximum Sample Rate: 1000 Hz

Resolution: ± 0.01 Lux at 1000 Hz on 0 to 100 scale; ± 0.0005 Lux at 5 Hz on 0 to 100 scale

Order Information

PASPORT Goniometer Sensor.....PS-2137

Order Information

PASPORT Broad Spectrum LightPS-2150

Order Information

PASPORT High Sensitivity Light.....PS-2176



PASPORT Infrared Light Sensor

PS-2148

The Infrared Light Sensor is sensitive in the infrared portion (up to 40,000 nm) of the spectrum, but also detects the visible spectrum. It can detect the radiation from a person's hand. The response is linear over its entire frequency range.

Features:

- ▶ Built-in thermistor to measure temperature of the "cold" side of the thermopile in °C, °F or K.
- ▶ Measures intensity in Watts/Meter² (W/m²)

Applications:

- ▶ Measure Blackbody radiance
- ▶ Perform Leslie's Cube experiments
- ▶ Measure solar radiance

Includes:

- Shutter with thumbscrew and washer

Specifications:

Maximum Sample Rate: 100 Hz

Spectral Response: 580 to 40,000 nm

Built-in Thermistor: Measures temperature of the "cold" side of the thermopile in °C, °F or K



PASPORT Load Cell and Dual Amplifier Set

PS-2206

The PASPORT Load Cell and Dual Amplifier Set can be used to test structure strength, manipulate force, and explore dynamic force relationships. The set includes the Dual Channel Load Cell Amplifier and one, 100 N Load Cell. You can insert a load cell by replacing one structure beam with a load cell connected to two, shorter beams. Multiple load cells can be purchased for more advanced structure experimentation.

Includes:

- 2 Load Cell Amplifiers (2-port)
- 100 N Load Cell

Highlights:

- Measure the compression and tension in the I-beam members
- Insert load cells into structures by substituting beams
- Use more than 6 load cells by connecting multiple amplifiers to one computer



100 N Load Cell



PASPORT Magnetic Field Sensor

PS-2112

The Magnetic Field Sensor provides magnetic field data in a compact package. The sensor at the tip of the probe measures magnetic field strength along the axis of the probe.

Features:

- ▶ Displays in gauss and millitesla
- ▶ Molded plastic protects the sensing element for enhanced durability
- ▶ Measures magnetic field along axis of probe

Applications:

- ▶ Study the field strength of bar magnets and electromagnets
- ▶ Understand the field strength of a solenoid
- ▶ Measure the field strength of a Helmholtz coil

Includes:

- Sensor handle

Specifications:

Range: ±1000 gauss

Accuracy: ±3 gauss or 5% of reading, whichever is greater at 25°C (after four minute warm-up)

Resolution: 0.1 gauss (0.01% full-scale)

Maximum Sample Rate: 20 Hz

Repeatability: 0.05%

Order Information

PASPORT Infrared Light Sensor.....PS-2148

Order Information

PASPORT Load Cell & Dual Amplifier Set.....PS-2206
100 N Load Cell.....PS-2200

Order Information

PASPORT Magnetic Field Sensor.....PS-2112



PASPORT 2-Axis Magnetic Field Sensor

PS-2162

Measure radial and axial fields simultaneously. Dynamic variable oversampling greatly reduces noise at low sample rates.

Includes:

- Sensor handle
- Sensor extension cable

How It Works:

Use the PASPORT 2-Axis Magnetic Field Sensor in conjunction with a PASPORT interface to measure magnetic field strength simultaneously along two perpendicular axes.

The sensing elements are two Hall Effect devices oriented perpendicularly to one another and located at the end of the sensor's probe. The sensor measures the magnetic field in the Axial and Perpendicular directions. Two white dots on the probe mark the positions of the sensing elements.

Highlights:

- Measures radial and axial fields
- Tare button

Specifications:

Range: ±1000 gauss

Accuracy: 5% of reading at 25°C (after four minute warm-up and Tare using Zero Gauss Chamber)

Resolution: 0.01 gauss at 10 Hz

Maximum Sample Rate: 1000 Hz

Repeatability: 0.05%



PASPORT Motion Sensor

PS-2103A

The PASPORT Motion Sensor is used to measure the position, velocity, and acceleration of a target. The Motion Sensor can be set on a desktop, mounted to a rod stand, or attached to a PASCO Dynamics Track. The ultrasonic, pulse-ranging technology has a switch-selectable Standard Beam or Narrow Beam that rejects false signals for cleaner data collection.

Features:

- ▶ Measures position, velocity, and acceleration
- ▶ False Target Rejection Technology collects clean data
- ▶ Switch-selectable short range and long range settings
- ▶ Snaps onto PASCO dynamics tracks
- ▶ Mounts to rods for easy positioning
- ▶ 360° pivoting head

Specifications:

Minimum Range: 0.15 meters

Maximum Range: 8 meters

Resolution: 1 mm

Maximum Sampling Rate: 250 Hz

Transducer Rotation: 360°

Narrow Near/Far Switch Settings: For distances up to 2 meters to reject false target signals or ignore air track noise.

Standard Near/Far Switch Settings: For longer distances up to 8 meters.

Cable Length: 1.8 meter

Mounting Options: Non-skid rubber feet for table mount.



PASPORT Rotary Motion Sensor

PS-2120A

The PASPORT Rotary Motion Sensor is used to measure position and motion within physics labs. It measures position, velocity, and acceleration, both angular and linear, with incredible resolution and accuracy. The maximum spin rate of 30 rev/sec and bi-directional orientation enables the PASPORT Rotatory Motion Sensor to facilitate the performance of most motion experiments.

Features:

- ▶ Three-step pulley (10, 29, and 48 mm in diameter)
- ▶ Rod clamp for dynamic mounting orientations
- ▶ Measures magnitude and motion direction
- ▶ Ball bearings minimize friction and provide mechanical support to rotating objects

Specifications:

Three-step Pulley: 10 mm, 29 mm, and 48 mm diameters

Sensor Dimensions: 10 cm x 5 cm x 3.75 cm, 6.35 mm diameter shaft

Rotary Motion Resolution: 0.09° (0.00157 rad)

Linear Motion Resolution: 0.0078 mm

Maximum Rotation Rate: 30 revs/sec

Rotary Motion Optical Encoder: Bidirectional to indicate the direction of motion; 4000 divisions/rev

Order Information

PASPORT 2-Axis Magnetic Field.....PS-2162

Order Information

PASPORT Motion SensorPS-2103A

Order Information

PASPORT Rotary Motion Sensor....PS-2120A



Picket Fence

ME-9377A

Conduct freefall experiments by dropping this Picket Fence through the PASCO Photogate. The distance from the leading edge of each black bar to the leading edge of the next black bar is 5.0 cm. The Picket Fence has eight black bars and is 40 cm long.



Cart Picket Fences (2 Pack) – IDS

ME-9804

These Picket Fences are included in PASCO's IDS Photogates and Fences Set (ME-9471A), and are available separately as replacement parts. The picket fences mount directly to PASCO's dynamics carts.



Order Information

Picket Fence ME-9377A
 Cart Picket Fences (2 Pack) ... ME-9804



Photogate Head

ME-9498A

The Photogate Head monitors the motion of objects passing through its gate, counting events as the object breaks the infrared beam. It includes a swivel mount to attach to a photogate stand. It does not include the heavy base and standard rod of the Accessory Photogate (ME-9204B). Can be used with ScienceWorkshop or PASPORT interfaces using a Digital Adapter (PS-2159).

Includes:

- Photogate Head with Cable

Specifications:

Photogate Width: 7.5 cm
Fall Time: < 50 ns
Spatial Resolution: < 1 mm
Timing Resolution: 0.1 millisecond
Connector: Stereo phone plug

Time-of-Flight Accessory

ME-6810A

The Time-of-Flight Accessory is designed primarily for freefall or projectile motion experiments. When an object hits the plate, a signal is sent to the interface. Note: When used with the Projectile Launcher, a photogate is used to start the timer and the 20' extension cable is recommended.

Recommended Accessory:

- ▶ Phone Jack Extender Cable PI-8117

Includes:

- Time-of-Flight Accessory
- Instruction Manual
- Experiment Guide



Order Information

Photogate Head ME-9498A
 Time-of-Flight Accessory ME-6810A



Smart Gate

PS-2180

The Smart Gate connects directly to any PASPORT interface, and has an auxiliary port to daisy chain to an additional Photogate. Can be used with cart picket fence, clamp-on super pulley, and flexible photogate tape.

Includes:

- Smart Gate
- PASPORT Cable
- Interface Cord

Highlights:

- Dual Photogate beams
- Photogate Tape Slot
- Daisy chain auxiliary Photogate or Time-of-Flight Accessory

Specifications:

Photogate Width: 7.5 cm
Fall Time: < 50 ns
Spatial Resolution: < 1 mm
Timing Resolution: 0.1 millisecond
Connector: Stereo phone plug

Order Information

Smart Gate PS-2180

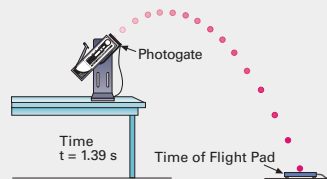

Timing begins when the photogate beam is broken and ends when the projectile hits the pad and the signal is sent to the interface.



PASPORT Alpha Beta Gamma Radiation Sensor

PS-2166

This highly sensitive Geiger-Muller Counter measures beta, gamma and alpha radiation. Provides audible beep for radiation count. Designed for easy mounting for superior position control in inverse square labs.

Includes plastic cap for protection of the mica membrane and Digital Adapter for connecting to PASPORT systems.

The Geiger-Muller Tube is also available separately (without the PASPORT adapter) and can be used directly with the 550 or 850 Universal Interfaces as well as legacy ScienceWorkshop interfaces such as the 500 or 750.

Includes:

- G-M Tube/Power Supply: SN-7927A
- PASPORT Digital Adapter: PS-2159

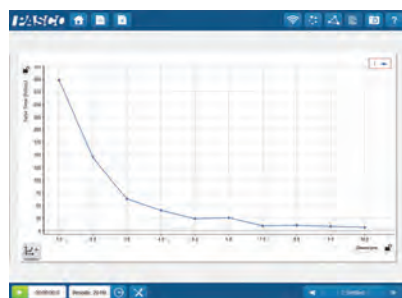

Students can compare their individual data to mathematical models.

Order Information

PASPORT Alpha Beta Gamma Radiation Sensor.....PS-2166



PASPORT Salinity Sensor

PS-2195

The PASPORT Salinity Sensor works with the 10X Salinity Sensor Probe to measure the salinity, conductivity, and temperature of fresh to brackish water sources. It determines salinity based on electrical conductivity and includes a built-in calculation to compensate for the change in conductivity due to temperature changes based on the Practical Salinity Scale (PSS).

The Salinity Sensor measures the electric current through a solution between the two platinum electrodes in the Salinity Sensor Probe. The current through the solution is due to the movement of ions, so the higher the concentration of ions in the solution, the higher its conductivity. A voltage (AC) is applied across the two electrodes in the tip of the probe and the measured current is proportional to the conductivity of the solution.

Recommended Accessories:

- ▶ PASPORT Sensor Extension Cable PS-2500

Specifications:

Conductivity Range: 1,000 to 100,000 $\mu\text{S}/\text{cm}$

Temperature Range: 0 to 50°C

Salinity Range: 1 to 55 ppt $\pm 1\%$ (with calibration)

Sample Rate (maximum): 50 Hz

Temperature Compensation: ± 0.5 ppt from 0 to 45°C at 33 ppt

Cell Constant: 10X

Order Information

PASPORT Salinity SensorPS-2195



PASPORT Soil Moisture Sensor

PS-2163

The Soil Moisture Sensor measures the water content of soil and reports it in percent. It can be used to conduct experiments in environmental science, agricultural science, horticulture, and biology.

Applications:

- ▶ Measure the loss of soil moisture over time due to evaporation and plant uptake
- ▶ Evaluate optimum soil moisture content for various species of plants
- ▶ Monitor soil moisture content to control irrigation in greenhouses

Specifications:

Range: 0 to 45% volumetric water content in soil

Probe Length: 5.5 cm

Probe Cable Length: 5 m

Accuracy: $\pm 4\%$

Resolution: 0.1%

Power: 3 mA at 5 V DC

Operating Temperature: -40 to 60°C

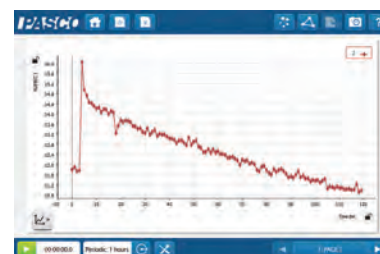

Soil moisture data over time shows evaporation.

Order Information

PASPORT Soil Moisture Sensor..... PS-2163



PASPORT Spirometer

PS-2152

With our Spirometer Sensor, students can easily measure flow rate, pressure, and lung volume, making it perfect for human physiology courses. The mouthpieces are designed to be used by a single student, and the sensor includes an exchangeable filter to ensure every use is hygienic. The Spirometer Sensor facilitates the safe and accurate measurement of airflow both inward (inspiration) and outward (expiration). Additional mouthpieces are available in convenient packs of ten.

Features:

- ▶ Bi-directional air flow (inspiration and expiration)
- ▶ Minimal resistance to airflow
- ▶ Displays volume in liters

Applications:

- ▶ Compare a student's airflow before and after exercise
- ▶ Investigate the lung volume of athletes vs. non-athletes
- ▶ Compare smokers vs. non-smokers
- ▶ Conduct respiratory experiments
- ▶ Determine total lung capacity

Includes:

- 2 Disposable Mouthpieces

Specifications:

Maximum Sample Rate: 100 Hz



PASPORT Fast Response Temperature Probe (3 pack)

PS-2135

Use with a Temperature Sensor to measure temperature in sensitive and fast-changing conditions, or study air convection, evaporative cooling, or endothermic and exothermic reactions. Temperature data displays immediately. For use with PASPORT and ScienceWorkshop Interfaces.

Features:

- ▶ Accurately measures temperature changes in real time
- ▶ Ideal for small or hard-to-reach spaces
- ▶ Includes 10 Adhesive Patches to hold the temperature probe in place
- ▶ 3.5-mm plug connects to the Wireless Temperature Link, SPARK LXI2, SPARKlink and SPARKlink Air, PASPORT Temperature and Quad Temperature sensors, and Xplorer GLX.

Includes:

- 3-pack of Fast Response Temperature Probes
- 10 Adhesive Patches

Specifications:

Range: -30 to +105°C



PASPORT Skin/Surface Temperature Probe

PS-2131

The PASPORT Skin/Surface Temperature Probe features a flat contact area with a wide, measurable range that allows students to measure a variety of surfaces. For use with PASPORT and ScienceWorkshop Interfaces.

Features:

- ▶ Wide temperature range allows a variety of surfaces and situations to be studied
- ▶ Flat surface areas assures good contact and accurate readings
- ▶ Quickly reaches equilibrium temperature with surfaces
- ▶ 3.5-mm plug connects to the Wireless Temperature Link, SPARK LXI2, SPARKlink and SPARKlink Air, PASPORT Temperature and Quad Temperature sensors, and Xplorer GLX

Specifications:

Range: -10 to +70°C

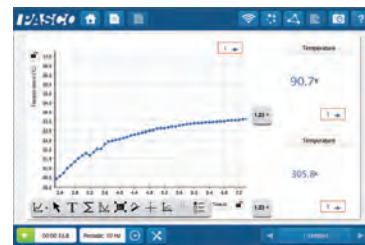

Report surface temperatures using degrees Celsius and Fahrenheit simultaneously.

Order Information

PASPORT Spirometer.....	PS-2152
Spirometer Mouth Piece Replacements (10).....	PS-2522
Spirometer Mouth Piece & Pre-Filter.....	PS-3245

Order Information

PASPORT Fast Response Temp Probe (3 pack)	PS-2135
---	---------

Order Information

PASPORT Skin/Surface Temp Probe.	PS-2131
---------------------------------------	---------



PASPORT Stainless Steel Temperature Probe

PS-2153

The PASPORT Stainless Steel Temperature Probe is a versatile probe with a wide range that covers most student lab needs. It connects to the Wireless Temperature Link Sensor, PASPORT and ScienceWorkshop temperature sensors, as well as the built-in temperature ports on the SPARK LXi2, Xplorer GLX, SPARK Science Learning System, SPARKlink and SPARKlink Air.

Features:

- ▶ 3.5-mm plug connects to the Wireless Temperature Link, SPARK LXi2, SPARKlink and SPARKlink Air, PASPORT Temperature and Quad Temperature sensors, and Xplorer GLX.

Applications:

- ▶ Melting point
- ▶ Freezing point
- ▶ Measure rapid temperature changes found in endothermic-exothermic reactions
- ▶ Conduct environmental studies

Related Accessories:

- ▶ Wireless Temperature Sensor Link PS-3222
- ▶ PASPORT Temperature Sensor PS-2125
- ▶ PASPORT Quad Temperature Sensor PS-2143
- ▶ Temperature Sensor CI-6605A

Specifications:

Range: -35 to +135°C



PASPORT Non-Contact Temperature Sensor

PS-2197

The Non-Contact Temperature Sensor measures surface temperature by detecting the emitted infrared light. Record the temperature of objects without touching them!

Applications:

- ▶ Compare temperature of hands, skin, face, and clothes
- ▶ Measure the temperature of different outdoor ground surfaces
- ▶ Map the temperature profile of an exterior wall

Highlights:

- Non-contact
- Broad Temperature Range

Specifications:

Range: -70°C to 380°C

Accuracy: ±0.5°C

Response Time: Less than 0.1 s

Maximum Sample Rate: 200 Hz

Field of View: ±35°



PASPORT Thermocline Sensor

PS-2151

At last, students can measure temperature as a function of depth in local streams and lakes. PASCO's Thermocline measures depth automatically — no need to read markings on a cable and enter data manually. Weighted housing provides depth measurement stability in fast-flowing streams.

Applications:

- ▶ Study thermoclines in fresh and salt water environments
- ▶ Create depth profiles for streams, small rivers, shorelines, and swimming pools
- ▶ Study ocean tides

Specifications:

Depth-Sensing Element Range:

0 m to 10.5 m

Depth-Sensing Element Accuracy:

0.15 m (in fresh water after barometric pressure compensation)

Depth-Sensing Element Resolution:

0.03 m

Temperature-Sensing Element Range:

0°C to 100°C

Temperature-Sensing Element

Accuracy: ±1.5°C

Temperature-Sensing Element Maximum Sample Rate: 10 Hz

Order Information

PASPORT Stainless Steel Temp Probe PS-2153

Order Information

PASPORT Non-Contact Temperature Sensor PS-2197

Order Information

PASPORT Thermocline Sensor PS-2151



PASPORT Dual Pressure Sensor

PS-2181

The Dual Pressure Sensor is capable of reading two absolute pressures, one gauge pressure, or one differential pressure. Dynamic variable over-sampling automatically reduces the measurement noise at low sampling rates. Sample rates up to 1000 Hz make studies of both transient and steady-state pressure possible. Includes quick-connect tubing.

Includes:

- 4 Quick-release Connectors
- 4 Tubing Connectors
- Polyurethane Tubing (2.4 m)

Highlights:

- Measure pressure at two pipe pressure taps at once

Specifications:

Maximum Sample Rate: 1000 Hz

Absolute Pressure: 0 to 200 kPa, 0.01 kPa resolution at 10 Hz and 1 kPa repeatability (displays pressure in kPa, N/m², and psi)

Differential Pressure: ±100 kPa, 0.01 kPa resolution at 10 Hz and 1 kPa repeatability (displays pressure in kPa, N/m², and psi)



PASPORT Water Quality Colorimeter

PS-2179

The PASPORT Water Quality Colorimeter is designed specifically to support the chemical analysis of water samples using PASCO's ezSample Snap Vial test kits (sold separately). It includes built-in calibration curves for determining the concentration of ions in the solution, making it incredibly simple to use in the classroom or field. Easy to use, and students avoid direct contact with chemicals!

Specifications:

Range: 0 to 100 % transmittance

Wave Lengths: 660 nm (red), 610 nm (orange), 565 nm (green), 461 nm (blue)

Accuracy: ±0.5 % transmittance

Resolution: 0.1 % transmittance

Default Sample Rate: 1 Hz

Maximum Sample Rate: 5 Hz

Operating Temperature: 0° to 40°C

Iron Test Kit Range: 1.5 to 8 mg/l

Nitrate Test Kit Range: 0.25 to 2 mg/l

Ammonia Test Kit Range: 0.20 to 3 mg/l

Phosphate Test Kit Range: 0.20 to 8 mg/l

Chlorine Test Kit Range: 0.50 to 6 mg/l

Total Hardness Test Kit Range:

20 to 200 mg/l

Dissolved CO₂ Test Kit Range:

10 to 100 mg/l

Alkalinity Test Kit Range:

10 to 100 mg/l



Electrodes

These PASCO Ion Selective Electrodes connect to PASCO's wired and Wireless pH Sensors and allow students to measure the concentration of the ions for which each one is named. Operation of these Ion Selective Electrodes assumes training in the safe handling of flammable, caustic and corrosive chemicals more typical of secondary and college settings. We do not recommend these for use by elementary or middle school students. This style of ISE utilizes a standard PVC membrane with a shorter lifespan than a typical pH sensor. We offer replacement PVC matrix sensor modules to replace the module, rather than the whole electrode.

Order Information

PASPORT Dual Pressure Sensor PS-2181

Order Information

PASPORT Water Quality Colorimeter PS-2179

Order Information

Ammonium Ion Selective Electrode PS-3516

Carbon Dioxide Ion Selective Electrode PS-3517

Calcium Ion Selective Electrode PS-3518

Chloride Ion Selective Electrode PS-3519

Potassium Ion Selective Electrode PS-3520

Nitrate Ion Selective Electrode PS-3521



Oxidation Reduction Potential Probe

PS-3515

This probe connects to the Wireless pH Sensor and allows students to determine the ability of a species in a solution to act as an oxidizing agent or reducing agent during redox reactions.

Use this probe to monitor solutions during oxidation-reduction titrations, perform water quality studies, and study the effects of water chlorination. This probe is not a standalone sensor. It connects to and requires an amplifier (PS-2102 or PS-3204).



Flat pH Probe

PS-3514

The Flat pH Probe gives you the freedom to measure what you want, where you want. Study pH levels in different kinds of foods, investigate the pH of common skin and hair care products, and easily collect pH data when doing soil analysis. Can be used on semi-solids by pressing the probe against a moist surface.

This product is intended for use with the Wireless pH Sensor.



PASPORT Analog Adapter

PS-2158

Use an Analog Adapter to connect ScienceWorkshop sensors with an 8-pin or 5-pin DIN connector to a PASPORT interface.

Applications:

- ▶ Remote data collection with Xplorer GLX and your ScienceWorkshop sensors
- ▶ AC/DC voltage experiments when used with a ScienceWorkshop Voltage Sensor
- ▶ Sound wave experiments when used with a ScienceWorkshop Sound Sensor

Related Accessories:

- ▶ PASPORT Digital Adapter PS-2159

Specifications:

Ranges: ± 10 V, with 5 mV resolution; ± 1 V, with 0.5 mV resolution; ± 0.10 V, with 50 μ V resolution

Absolute Maximum Input Voltage Range Without Damage: -40 V to +40 V

Input Impedance: 1 M Ω

Gain: 1, 10, and 100 (selectable in software)

Maximum Sampling Rate: 50 kHz with Xplorer GLX / 1000 Hz with other interfaces

Analog-to-Digital Conversion: 12 bit

Offset Voltage Accuracy: $< \pm 5$ mV

Full-Scale Voltage Accuracy: $< \pm 15$ mV



PASPORT Digital Adapter

PS-2159

The Digital Adapter is required to connect digital ScienceWorkshop sensors to PASPORT interfaces. Each Digital Adapter has two ports that can accommodate two single-channel digital sensors, or one dual-channel digital sensor. Each port on the Digital Adapter automatically detects a connection and initiates the selection of pre-configured or user-defined options. Several Digital Adapters can be used simultaneously when required.

Applications:

- ▶ Velocity of carts on a track
- ▶ Freefall
- ▶ Projectile motion
- ▶ Nuclear Radiation

Related Accessories:

- ▶ PASPORT Analog Adapter PS-2158

Specifications:

Resolution for Counting and Timing Devices: 2 μ s

Resolution for Motion Sensors: 1 μ s

Input: Two 1/4" stereo phone jacks

Order Information

Oxidation Reduction Potential Probe PS-3515
Flat pH Probe PS-3514

Order Information

PASPORT Analog Adapter PS-2158

Order Information

PASPORT Digital Adapter PS-2159

Gratnells® Rolling Carts - Convenient Mobile Storage

EP-3574 (2-column) EP-3575 (3-column)



Gratnells Rolling Cart (2- or 3-column)

EP-3574 / EP-3575

Gratnells Rolling Carts are the best way to store and transport PASCO sensors and equipment. They can be configured for trays of any size and include large castors with brakes for added stability.

Designed for Gratnells trays, these movable storage rack carts can store up to 8 (2-column) or 12 (3-column) Gratnells F2 trays (sold separately). Each cart comes with either 16 or 24 pairs of runners.

They can be used to store the equipment kits from the Essential Physics or Essential Chemistry curriculum, the storage trays we offer for wireless sensors, or any of the four sizes of empty trays that we offer for everything else you'd like to store.

Assembly is required. Trays not included.



Stores up to
12 Gratnells
F2 trays

Dimensions:
107 cm high,
102 cm wide,
43.5 cm deep



Stores up to
8 Gratnells
F2 trays

Dimensions:
107 cm high,
70 cm wide,
43.5 cm deep



Order Information

Gratnells Rolling Cart (2-column)	EP-3574
Gratnells Rolling Cart (3-column)	EP-3575

Wireless Sensor Storage Trays with Lids

Each F1 storage tray (below) holds up to ten sensors; sensors sold separately.



**Temperature/pH/
Conductivity Sensors**
PS-3585



Pressure Sensors
PS-3586



**Colorimeter & Turbidity
Sensors**
PS-3587



**Voltage & Current
Sensors**
PS-3588



Motion Sensors
PS-3589



**AirLink & Light
Sensors**
PS-3594



**Force
Acceleration
Sensors**
PS-3595



**Weather Sensor
with GPS**
PS-3596



CO₂ Sensor
PS-3598

Order Information

Storage for Wireless Temperature, pH and Conductivity SensorsPS-3585
Storage Tray for Wireless Pressure Sensors.....PS-3586
Storage Tray for Wireless Colorimeter and
Turbidity Sensor.....PS-3587
Storage Tray for Wireless Voltage & Current Sensor.PS-3588
Storage Tray for Wireless Motion SensorPS-3589

Order Information

Storage Tray for Wireless Light Sensor and AirLink.....PS-3594
Storage Tray for Wireless Force SensorPS-3595
Wireless Weather Sensor Storage TrayPS-3596
Wireless CO₂ Sensor Storage Tray.....PS-3598

Gratnells® Storage Trays with Lids

These empty Gratnells storage trays with lids have a length of 427 mm and width of 312 mm. The depth of each follows:

F1: 75 mm **F25:** 225 mm
F2: 150 mm **F3:** 300 mm

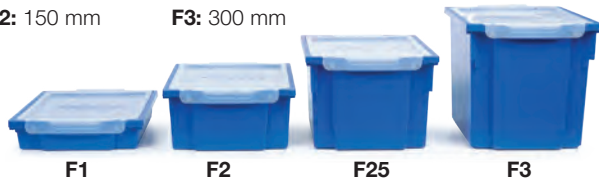

Order Information

Storage Tray (F1) ShallowPS-3326
Storage Tray (F2) Deep.....PS-3327
Storage Tray (F25) X-DeepPS-3328
Storage Tray (F3) JumboPS-3329

Storage Bins

SE-7560

These stackable plastic bins with lids can be useful for storing equipment and accessories in your lab.

14" L x 9.5" W x 6.9" D



Order Information

Storage Bins (Set of 5)SE-7560

Wireless Sensor Charging Station

This versatile charging station can be configured to fit any size sensor by adding or removing partitions.



Order Information

Wireless Sensor Charging StationPS-3599

2-Axis Magnetic Field Sensor.....	135
3-Axis Acceleration/Altimeter, Wireless	97, 108
3-Axis Magnetic Field Sensor, Wireless	69, 97, 117
100 N Load Cell.....	134
5-Year Warranty.....	108,150
550 Universal Interface	102-103

— A —

AC/DC Module, Modular Circuits.....	89
Absolute Zero Sphere.....	57
Acceleration/Altimeter, 3-Axis Wireless	79, 92
Adapters, Digital & Analog	141
Advanced Biology Through Inquiry Lab Manual	34
Advanced Chemistry Through Inquiry Lab Manual	52
Advanced Enviro Through Inquiry Lab Manual	68
Advanced Physics 1 Lab Manual & Equipment Kits	80-81
Advanced Physics 2 Lab Manual & Equipment Kits	82-83
Advanced Physics Sensor Bundle	81, 83
Advanced Water Quality Sensor	77
Agricultural Science Lab Stations	67, 69
Ag. Science Labs and Manuals	67, 69
AirLink Interface	46, 77, 103, 125, 128
Alpha Beta Gamma Radiation Sensor PASPORT	137
Wireless	60, 99, 115
Augmented Reality	12-13

— B —

Balance.....	56
Bluetooth Adapter	56
Ballistic Cart Accessory	93
Biology	32-47
Biology, Advanced.....	34
Biology Labs	33-35
Biology Lab Stations	33, 35
Biology Through Inquiry Teacher Resources.....	34
Blockly Coding	20, 105
Blood Pressure Sensor, Wireless	44, 109
Breath Rate Sensor	129
Breath Rate Sensor Filters & Mouth Pieces	129
Broad Spectrum Light Sensor.....	133

— C —

Capstone Software.....	104-107
Cart Picket Fences	136
Charge Sensor.....	129
Charging Station.....	143
Chemical Water Quality Testing.....	76, 140
Chemistry	48-65
Chemistry, Advanced	52-53
Chemistry Labs.....	49, 52
Chemistry Lab Stations	49, 53
Chemistry Through Inquiry Teacher Resources.....	52
Electrochemistry	59
//code.Node	21-22, 110
//code.Node Kits	18-19, 23-25
Coding	18-31
Coding with, Sensor Technologies Kit	23
Sound & Light Sensor Technologies Kit.....	25
Vehicle Sensor Technologies Kit	24
Sense & Control Kit, Greenhouse.....	30-31, 41, 75
Sense & Control Kit, PASCObot.....	28-29
CO ₂ Sensor, Wireless.....	17, 40, 70, 109
Waterproof Sleeve	70, 109
Colorimeter & Turbidity Sensor, Wireless	42, 62, 76, 110
Color Mixer.....	15
Conductivity Sensor, Wireless.....	38, 58, 73, 111
Constant Speed Buggy	16
//control.Node	111
Sense & Control Kits.....	26-31
Current Sensor, Wireless	59, 100, 112
Curriculum & Equipment Kits	50-51, 84-87
Cuvettes and Caps.....	62
Disposable Cuvettes	65
Quartz Cuvettes.....	43, 65
UV Semi-Micro Volume Cuvettes	65

— D —

Density Circulation Model	74
Diffusion/Osmosis Kit.....	39
Displacement Sensor	129
Disposable Cuvettes	65
Dissolved CO ₂ Waterproof Sleeve	70, 109
Dissolved Oxygen Sensor	41, 74, 118
Drop Counter, Wireless.....	55, 112
Dual Pressure Sensor.....	140

- E -

Eclipse Data81
EcoZone System42, 75
EKG Sensor + Electrode Patches
 PASPORT130
 Wireless45, 113
Electrochemistry.....44
Electrodes & Probes.....140
 Ammonium140
 CO₂.....140
 Calcium.....140
 Chloride140
 Nitrate140
 Potassium.....140
Elementary (K-5) Science 8-11
 Elementary Science Lab Stations.....9
Environmental Science..... 66-77
 Advanced Enviro Science Through Inquiry
 Teacher Lab Manual.....68
 Enviro Labs..... 67-68
 Enviro Lab Stations67, 69
 Enviro Teacher Resources68
 Water Quality Field Guide + Sensors..... 69, 76-77, 140
Essential Biology Teacher Lab Manual.....33
Essential Chemistry
 Curriculum + Equipment..... 50-51
 Lab Manual.....51
 Teacher Resources..... 50-51
Essential Physics
 Curriculum + Equipment..... 84-87
 Lab Manual & Kits 86-87
 Forces & Kit.....87
 Light, Color & Optics Kit87
 Modular Circuits Kit 87-89
 Oscillations, Waves & Sound Kit87
 Simple Machines Engineering Kit87
 Teacher Resources..... 84-85
Ethanol Sensor130
Exercise Heart Rate Sensor, Wireless44, 113
ezSample Snap Vial & Field Titrator Kits.....76

- F -

Fast Response Temperature Probe.....138
Fiber Optic Cable
 UV-Vis43, 65
 Vis.....96

Flat pH Probe141
Flow Rate Temp Sensor77, 130
Force Acceleration Sensor, Wireless..... 16, 100, 114
Force Platforms, 1- & 2-Axis
 PASPORT 131-132
 Wireless101, 114
Force Sensor, High Resolution.....131
Force Sensor, PASPORT131
Forces & Motion Kit.....87

- G -

Galvanometer132
Geiger Counter.....60, 99, 115
 Sample Holder.....60, 99, 115
General Science Sensor.....132
Goniometer Sensor + Probe.....133
GPS Sensor..... see Wireless Weather Sensor
Greenhouse Sense & Control Kit..... 30-31, 41, 75
Greenhouse Sensor.....30, 115

- H -

Hand-Grip Heart Rate Sensor, Wireless.....44, 116
Heater-Stirrer.....56
High Sensitivity Light Sensor133
Human Arm Model46
Human Eye Model.....47

- I -

Ideal Gas Law Apparatus57
Infrared Light Sensor.....134
Interface Comparison.....103
 550 Universal Interface 102-103
 AirLink.....46, 77, 103, 125, 128
 SPARK LXi 2 82-83, 106, 124
 SPARKlink Air103, 125
Ion Selective Electrodes.....140
 Ammonium140
 CO₂.....140
 Calcium.....140
 Chloride140
 Nitrate140
 Potassium.....140

- J-K-L -

Lab Stations6
 Agricultural Science.....67, 69

Biology.....	33, 35
Chemistry	49, 53
Elementary.....	9
Middle School.....	14
Physics	79
Light, Color & Optics Kit	87
Light Sensor, Broad Spectrum	133
Light Sensor, High Sensitivity.....	133
Light Sensor, Infrared	134
Light Sensor, Wireless	10, 15, 39, 73, 98, 116
Eclipse Data.....	98
Load Cell & Dual Amplifier Set	134
Load Cell, 100 N.....	134
Load Cell Accelerometer, Wireless.....	117

— M —

Magnetic Field Sensor,	
PASPORT	134
PASPORT 2-Axis	135
Wireless 3-Axis	69, 97, 117
MatchGraph,	
Free Motion-Graphing Software.....	90
Metabolism Chamber.....	40
Microscopes.....	47
MindLabs Energy & Circuits	12-13
Mini Launcher	95
Middle School Science	14-17
Middle School Science Lab Stations	14
Middle School STEM.....	18-31
Modular Circuits & Kits	87-89
Molecular Model Set	60
Motion Sensors,	
PASPORT	135
Wireless	11, 16, 90, 118
Motor, Smart Cart.....	94

— N —

Nitrate Ion Selective Electrode.....	140
Non-Contact Temperature Sensor	139

— O —

O ₂ Gas Sensor, Wireless	40, 119
Ohaus Scout SKX Balance.....	56
Optical Dissolved O ₂ Sensor,	
Wireless	41, 74, 118
Metal Guard.....	41, 74
Oscillations, Waves & Sound Kit	87
Oxidation Reduction Potential Probe.....	53, 141

— P —

PASCO Academy	See Essential Curriculum
PASCObot	26-29
Gripper Accessory.....	29
Line Follower Module	29
Range Finder Module	29
Sense & Control Kit	28-29
Servo Motor.....	29
pH Sensor, Wireless	17, 37, 54, 72, 119
Photosynthesis Tank	41
Photogate & Accessories	136
Physics Solutions	78-107
Physiology Extension Bundle.....	35
Picket Fences.....	136
Polarimeter, Wireless	61, 120
Polarizer Demonstrator.....	61
Pressure Sensor, Wireless	35, 58, 98, 120
Probes & Electrodes.....	140
Professional Development.....	152
Projectile Launcher.....	95

— Q-R —

Robotics	see PASCObot
Rolling Storage Carts	142
Rotary Motion Sensor,	
PASPORT	135
Wireless	94, 121

— S —

Salinity Sensor.....	77, 137
Sense & Control Kits	26-31
Greenhouse Sense & Control Kit.....	30-31, 41, 75
PASCObot Sense & Control Kit.....	28-29
Sensor Charging Station	143
Sensor Extension Cable	119
Sensor Index,	
PASPORT	128
Wireless	108
Simple Machines Engineering Kit	87
Simple Machines Teacher Resources	91
Skin Surface/Temperature Probe	138
Smart Ballistic Cart Accessory.....	93
Smart Cart, Wireless.....	16, 91, 122
Smart Cart Charging Garage.....	91, 122
Smart Cart Demo Kit	87, 92
Smart Cart Motor.....	94
Smart Cart Vector Display	92
Smart Fan Accessory	93
Smart Gate	136
Smart Gate, Wireless.....	95, 121

Projectile Launcher	
Wireless Smart Gate System	95
Soil Moisture Sensor	
PASPORT	137
Wireless	36, 70, 123
Sound Sensor, Wireless.....	15, 96, 123
SPARK LXi 2	102-103, 124
SPARKlink Air	103, 125
SPARKvue 4	4-5
Spectrometer	
Comparison Chart	64
UV-Vis	43, 64-65
Wireless Vis	43, 53, 63-64, 96, 125
Spectrometry Software	65
Spirometer	
PASPORT	138
Wireless	29, 120, 126
Stainless Steel Temp Probe.....	139
STEM Sense.....	18-31
Coding with,	
Sensor Technologies Kit	23
Sound & Light Sensor Technologies Kit.....	25
Vehicle Sensor Technologies Kit	24
Sense & Control Kit, Greenhouse.....	30-31, 41, 75
Sense & Control Kit, PASCObot.....	28-29
Storage Solutions.....	142-143

- T -

Temperature Link, Wireless	57, 126
Temperature Sensor,	
PASPORT	77, 138-139
Wireless	10, 17, 37, 56, 72, 100, 126
Thermocline Sensor	139
Time-of-Flight Accessory	136

- U -

Universal Interface, 550.....	102-103
USB 3.0 Microscope Camera.....	47
UV-Vis Spectrometer.....	43, 64-65

- V -

Voltage Sensor, Wireless	59, 100, 127
Visible Spectrometer	43, 53, 63-64, 96, 125

- W-X-Y-Z -

Water Quality Colorimeter	140
Water Quality Field Guide + Sensors	69, 76-77
Water Quality Testing Kits	76
Wave Motion Demonstrator	15

Weather Sensor with GPS,	
Wireless	11, 17, 36, 71, 127
Weather Vane Accessory	17, 36, 71
Wireless AC/DC Module.....	71
Wireless Sensor Charging Station.....	143
Wireless Sensor Index.....	108

Wireless Sensors

3-Axis Acceleration/Altimeter	97
3-Axis Magnetic Field.....	69, 97, 117
AirLink.....	46, 77, 103, 125, 128
Blood Pressure	44, 109
CO ₂ Sensor	17, 40, 70, 109
//code.Node.....	21-22, 110
Colorimeter & Turbidity	42, 62, 76, 110
Conductivity.....	38, 58, 73, 111
//control.Node	19, 26-31
Current.....	59, 100, 112
Drop Counter.....	55, 112
EKG	45, 113
Exercise Heart Rate.....	44, 113,
Force Acceleration.....	16, 100, 114
Force Platforms	101, 114
Geiger Counter	60, 99, 115
Greenhouse	115
Hand-Grip Heart Rate.....	44, 116
Ideal Gas Law Apparatus Wireless Bundle	
Light.....	10, 15, 39, 73, 98, 116
Load Cell Accelerometer	117
Magnetic Field, 3-Axis.....	69, 97, 117
Motion.....	11, 16, 90, 118
O ₂ Gas.....	40, 119
Optical Dissolved O ₂	41, 74, 118
pH.....	17, 37, 54, 72, 119
Polarimeter	61, 120
Pressure.....	38, 58, 98, 120
Projectile Launcher +	
Wireless Smart Gate System	95
Rotary Motion.....	94, 121
Smart Cart	16, 91, 122
Smart Gate	95, 121
Soil Moisture.....	36, 70, 123
Sound	15, 96, 123
SPARK LXi 2	102-103, 124
SPARKlink Air	103, 125
Spectrometer.....	43, 53, 63-64, 96, 125
Spirometer	44, 126
Temperature.....	10, 17, 37, 56, 72, 100, 126
Temperature Link.....	57, 126
Voltage.....	59, 100, 127
Weather w/GPS	11, 17, 36, 71, 127

PART NUMBER INDEX

CI-6605A	139	OS-8496	15
CI-6620	130	OS-9477A	61
EB-6331	33	PI-8117	136
EB-6334	33	PS-2011	103, 125
EB-6335	35	PS-2103A	135
EB-6336	67, 69	PS-2104	131
EB-6337	67, 69	PS-2111	130
EC-6330	51	PS-2112	134-135
EC-6350, EC-6350-EB1	51	PS-2120A	135
EC-6352	51	PS-2125	139
EC-6353-DIG	51	PS-2130	77, 130
EC-6361	51	PS-2131	138
EC-6362	49, 53	PS-2132	129
EC-6363	49, 53	PS-2135	138
EM-3533	89	PS-2137	133
EM-3535	88	PS-2138	133
EM-3536	88	PS-2141	131-132
EM-3540	88	PS-2142	131-132
EP-3558	87	PS-2143	139
EP-3567A	86	PS-2148	134
EP-3574	142	PS-2150	133
EP-3575	142	PS-2151	139
EP-3576	87	PS-2152	138
EP-3577	87	PS-2153	139
EP-3578	87	PS-2158	141
EP-3579	79	PS-2159	141
EP-3580	79	PS-2160	132
EP-6323, EP-6323-EB1	85	PS-2162	135
EP-6326	85	PS-2163	137
EP-6328-DIG	85	PS-2166	137
EP-6329	86	PS-2168	132
EP-6353-EB1-8	84	PS-2176	133
EP-6490A	86-87	PS-2179	140
EZ-2331	76	PS-2180	136
EZ-2333B	76	PS-2181	140
EZ-2334A	76	PS-2187	129
EZ-2337	76	PS-2189	131
EZ-2338	76	PS-2194	130
EZ-2339A	76	PS-2195	77, 137
EZ-2340	76	PS-2197	139
ME-1240	16, 91, 122	PS-2200	134
ME-1241	16, 91, 122	PS-2204	129
ME-1242	93	PS-2206	134
ME-1243	91	PS-2230	77
ME-1245	93	PS-2343	47
ME-1246	92	PS-2400, PS-2400-DIG	4-5
ME-1247	94	PS-2401, PS-2401-DIG	4-5
ME-1272	87, 92	PS-2500	137
ME-1273	87, 92	PS-2521B	41
ME-6668	42, 75	PS-2522	45, 126, 129
ME-6796	95	PS-2567	129
ME-6800	95	PS-2568	129
ME-6810A	136	PS-2600	43, 53, 63-64, 96, 125
ME-6816	74	PS-2601	96
ME-6825B	95	PS-2611	46
ME-6936	40	PS-2828A	52
ME-6942	39	PS-2829A	69
ME-8971	81	PS-2852A	34
ME-9377A	136	PS-2935D	35
ME-9498A	136	PS-2979	68
ME-9804	136	PS-2994	27
NU-3344	60, 99, 115	PS-2997	30-31, 41, 75
OS-8477A	47		

PS-3200	46, 77, 103, 125, 128	PS-3565	116
PS-3201	10, 17, 37, 56, 72, 100, 126	PS-3585	143
PS-3202	16, 100, 114	PS-3586	143
PS-3203	38, 58, 98, 120	PS-3587	143
PS-3204	17, 37, 54, 72, 119	PS-3588	143
PS-3206	44, 116	PS-3589	143
PS-3207	44, 113	PS-3594	143
PS-3208	17, 40, 70, 109	PS-3595	143
PS-3209	11, 17, 36, 71, 127	PS-3596	143
PS-3210	38, 58, 73, 111	PS-3598	143
PS-3211	59, 100, 127	PS-3599	143
PS-3212	59, 100, 112	PS-3604	41, 74
PS-3213	10, 15, 39, 73, 98, 116	PS-3812	80-81
PS-3214	55, 112	PS-3813	81
PS-3215	42, 62, 76, 110	PS-3814	81
PS-3216	117	PS-3815	82-83
PS-3217	40, 119	PS-3816	83
PS-3218	44, 109	PS-3817	83
PS-3219	94, 121	PS-3818	81, 83
PS-3220	94, 121	SE-6203	47
PS-3221	69, 97, 117	SE-6204	47
PS-3222	57, 126	SE-6205	47
PS-3223	97	SE-7170	13
PS-3224	41, 74, 118	SE-7171	13
PS-3225	95, 121	SE-7172	13
PS-3227	15, 96, 123	SE-7173	13
PS-3228	36, 70, 123	SE-7560	140
PS-3229	101, 114	SE-8028A	16
PS-3230	101, 114	SE-8739	62
PS-3231	21-22, 110	SE-8823A	56
PS-3232	111	SE-8822	56
PS-3233	22	SE-9601	15
PS-3234	45, 126	ST-7800	23
PS-3235	24	ST-7820	24
PS-3236	45, 113	ST-7830	25
PS-3237	61, 120	ST-7840	28-29
PS-3238	60, 99, 115	ST-7850	30-312
PS-3245	45	TD-8595	57
PS-3311	22	TD-8596A	57
PS-3314	9	TD-8825A	41
PS-3315	9	UI-5001	102-103
PS-3320	29	UI-5400	104-107
PS-3321	29	UI-5401	104-107
PS-3322	115	UI-5405	104-107
PS-3325	29	UI-5406	104-107
PS-3326	143		
PS-3327	143		
PS-3328	143		
PS-3329	143		
PS-3400	60		
PS-3401	56		
PS-3504	116		
PS-3514	141		
PS-3515	53, 141		
PS-3516	140		
PS-3517	140		
PS-3518	140		
PS-3519	140		
PS-3521	140		
PS-3520	140		
PS-3545	70, 109		
PS-3553	17, 36, 71		

TERMS and CONDITIONS

The PASCO Promise of Learning (90-day Satisfaction Guarantee)

We are confident that PASCO solutions will help your students achieve more in science. Within the first 90 days, if you are not satisfied that your students are more engaged and learning more effectively, return your purchase for a refund. We don't want you spending precious budget dollars on something you don't use. (We are sorry but we must exclude non-PASCO software that has been opened, radioactive products and products that contain perishables.) See instructions for Returns below.

PASCO 5-Year Limited Warranty for Education

PASCO products are built to survive. PASCO-manufactured products are covered by a limited warranty for a period of 5 years from delivery date against defects in material and workmanship. This warranty is valid for educational institution customers and only for educational use of these products. The PASCO warranty does not extend to any product, including touch screens, which have been subject to abuse, neglect, accident, improper installation or application, or products that have been repaired or altered outside of our factory. Consumables and limited-life products (such as pH probes, membranes, fast response temperature probes, batteries, chemical solutions, printed materials, etc.) are excluded.

Other Warranty Terms

The **SPARK LXI2 datalogger** carries a limited warranty for a period of 3 years from delivery date against defects in material and workmanship. This limited warranty applies only to hardware components of the SPARK LXI2 that are not subject to accident, misuse, neglect, fire, or other external damage. This warranty can also be voided by unauthorized use, alterations, or repair. This warranty is valid for education institution customers and only for educational use of these products.

Products manufactured by anyone other than PASCO are subject to the conditions of the warranty supplied by the manufacturer (generally 1 year). Additional warranty information on our products is available upon request.

Free Teacher and Technical Support

We want teachers to be successful with PASCO solutions. Please contact our support team with any questions via phone or email: +1 916-786-3800 or support@pasco.com. We are here to help.

SPARKvue Licenses

SPARKvue software may be purchased as a Single License for use with one computer or as a Site License for use on all computers on a K-12 campus or in a college/university department.

SPARKvue for iPad®, Chromebook™, or Android™ tablets is licensed separately and is free through the App Store, the Chrome Web Store and Google Play. See pasco.com for more information.

PASCO Capstone Licenses

PASCO Capstone may be purchased as a Single License for use with one computer, or as a Site License for use on all computers on a primary and secondary campus or in a college/university department.

e-Book Licenses for Essential Chemistry and Essential Physics

For complete information on our e-book licenses, go to pasco.com/essentialchemistry or pasco.com/essentialphysics.

Shipping

Items in stock will normally be shipped in less than five working days from receipt of the order. Specific requests for air shipments or special carriers will be honored at an additional cost.

Returns

Please contact the authorized PASCO representative in your country for assistance in returning equipment for repair. PASCO's International Customer Service team can be reached at +1-916-786-3800 or at custserv@pasco.com. Out-of-Warranty products must be shipped prepaid, door-to-door. Returns for credit or exchange must be in new condition and packaged in original shipping cartons or packaging sufficient to prevent damage during international transport.

Trademarks

PASCO, PASCO scientific, PASCO Capstone, EcoZone, ezSample, MatchGraph!, MultiMeasure Sensors, ScienceWorkshop, SPARKscience, SPARK Element, SPARKvue, SPARKvue HD, SPARKlab, SPARKlink, PASPORT, //code.Node and Tension Protractor are trademarks or registered trademarks of PASCO scientific in the United States and/or in other countries. All other brands, products or service names are or may be trademarks or service marks of, and are used to identify products or services of, their respective owners. For more complete information visit pasco.com/legal.

More Product Information

Designed for education. PASCO products are designed for education; they are not intended for use in graduate research or industry, and should not be used in any apparatus involved with life support, patient diagnosis, or industrial control.

PASCO reserves the right to change the specifications of any product without prior notice. If a product is no longer available, PASCO reserves the right to substitute a product of equal, or higher, value and functionality.

FCC

Where appropriate, electrical products are marked to indicate that they conform to Federal Communications Commission (FCC) standards. Most commonly, FCC Part 15, Class A.

CE MARK

Where appropriate, products carry the CE marking, which indicates that they conform to the applicable European standards. This almost exclusively applies to products that are designed to meet the following applicable directives:

2014/30/EU	EMC Directive
2014/35/EU	Low Voltage Directive
2011/65/EU	RoHS Recast/RoHS-2
2014/53/EU	Radio Equipment Directive

Other Regulations May Apply

Local, national, and international regulations may restrict the purchase, storage, transport, use or disposal of certain products such as chemicals, radioactive sources, and specialty products and wireless transmission devices. Please consult your local regulations to ensure compliance.

Unless Otherwise Specified:

- Operating Temperature Range:
0°C – 40°C (32°F to 104°F).
- Maximum Altitude (Operational): 10,000 feet
- Recommended Storage Temperature:
10°C to 27°C (50°F to 80°F)

Quality

PASCO scientific Meets the Highest Quality Standards, and our Quality Management System is Registered to ISO 9001.

PASCO and the Environment

PASCO is committed to be in compliance with all laws and requirements in the countries in which our products are sold. PASCO is a responsible steward of the environment and as such, continually seeks to minimize the impact that our manufacturing, distribution, and consumption practices make on the planet's natural resources.

Miscellaneous



RoHS

European Union Restriction of Hazardous Substances. EU Directives 2011/65/EU:

- All applicable electrical products supplied by PASCO to the EU meet the requirements as specified in the RoHS directive either by substance limits or by product exemptions.

EU WEEE

Waste Electrical and Electronic Equipment. EU Directive 2012/19/EC, Effective July 4, 2012:

- All applicable products supplied by PASCO to the EU meet the requirements as specified in the WEEE directive and are marked with the WEEE symbol.

WEEE-Product End of Life Disposal Instructions (Reference):

Electronic products are subject to disposal and recycling regulations that vary by country and region. It is a user's responsibility to recycle electronic equipment per local environmental laws and regulations to ensure that equipment is recycled in a manner that protects human health and the environment. To find equipment recycling drop-off locations, please contact your local waste recycle/disposal service or the product representative.



The European Union (EU) WEEE (Waste Electrical and Electronic Equipment) symbol on our products and packaging indicates that this product must not be disposed of in a standard waste container.

EU REACH

Registration, Evaluation and Authorization of Chemicals, as of: Oct. 28, 2008:

- PASCO has reviewed the REACH SVHC list and, according to our current knowledge, cables supplied with some products may contain certain phthalate plasticizers at greater than 0.1% by weight
- Regarding the other SVHC's, to the best of our knowledge, none are present in PASCO products (articles) at concentrations of greater than 0.1% by weight

Battery Replacement and Disposal Instructions (Reference):

Batteries contain chemicals that, if released, may affect the environment and human health. Batteries should be collected separately for recycling, and recycled at a local hazardous material disposal location adhering to your country and local government regulations. To find a battery recycling drop-off location, please contact local waste disposal service or the product representative.



The battery or batteries used in PASCO products are marked with the European Union symbol for waste batteries that indicate the need for separate collection and recycling. For small batteries, the symbol is printed on the packaging.

EU Battery Directive



EU Directive 2006/66/EC on Waste Batteries:

- The European Union (EU) battery directive aims to reduce the environmental impact of waste batteries and accumulators.
- According to our specifications, all products supplied by PASCO Scientific into the EU that contain batteries meet the battery directive requirements, and are marked with the battery symbol.

PASCO

Since 1964

The Global Leader in 21st Century
Science Education

Supporting educators in over
100 countries around the world

When you have questions or need service, we want someone who understands your local needs. We carefully select, train, and support local Science Education Partners to serve our customers in each country.

When you work with a PASCO Science Education Partner, have confidence that the entire company here in California is ready to assist our Partner – and you, our Customer.

*Designed in California.
Guaranteed by PASCO.
Supported locally.
Serving science educators.*



+1 916-786-3800

ISO 9001 Certified





Professional Development

Led by our team of teachers and curriculum experts, PASCO's professional development opportunities provide teachers with the training they need to successfully model scientific phenomena and improve student learning through data collection and analysis.

At PASCO, we know the most valuable PD comes from real educators with real classroom experience. Our PD team has experience teaching across subjects and grade levels, enabling them to provide tailored training, relevant pedagogy, and meaningful models for authentic science teaching.

As a teacher, your time is in high demand, which is why we work with you to develop a PD solution specifically for your needs. Whether you're looking for a quick how-to, step-by-step software training, or a week-long Summer Institute, our PD team makes it easy to get the training you need when you need it.



Join one of our live webinar trainings!

Our live webinars are free to attend and cover a wide range of topics. Visit pasco.com/pd to register for the latest webinar updates.



Browse the online training video library

Learn at your own pace with hundreds of training videos, available from our online video library.

Get updates at www.pasco.com/pd

Worldwide Coverage & World-Class Support

PASCO

PASCO's global network of factory-trained partners are science specialists, knowledgeable about PASCO Solutions. Contact our team today to see how PASCO can update your labs and provide value for years to come.

Find Your Local Representative
pasco.com/support

Follow PASCO:



Live Contact Hours:

M–Th: 7:00 am–4:30 pm
F: 7:00 am–2:00 pm
Pacific Time



Phone:

+1 916.786.3800 (outside US)
800.772.8700 ext. 1004
(inside US)
Fax: 916.786.7565



Mail:

PASCO Scientific
10101 Foothills Blvd.
Roseville, California
95747-7100 USA
ISO 9001:2015 Certified



Email:

support@pasco.com



Web:

Order and quote online
pasco.com



Chat on pasco.com

Providing educators worldwide with innovative solutions for teaching science



NEW

GREENHOUSE KIT

Transform your classroom into a field site with the new Greenhouse Sense and Control Kit! **(Pages 30-31)**



SENSE & CONTROL

Power student creativity with the new //control.Node and sensors!

